

TIMTER™ Multi-mode Digital Telemetry Transmitter

Installation and Operation Manual



Quasonix, Inc.
6025 Schumacher Park Dr.
West Chester, OH 45069
21 March 2025

Revision 3.9.20



Specifications subject to change without notice.

All Quasonix transmitter products are under U.S. Department of Commerce jurisdiction and categorized as EAR99; not covered by ITAR.

No part of the document may be circulated, quoted, or reproduced for distribution without prior written approval from Quasonix, Inc.

Copyright Quasonix, Inc., All Rights Reserved.

Table of Contents

1 Introduction 1

1.1 Description 1

1.2 Nomenclature 1

1.3 Part Number Field Codes 3

1.3.1 Frequency Bands 3

1.3.2 Clock and Data Interface 5

1.3.3 Serial Control Interface 7

1.3.4 ARTM Tier 0 (PCM/FM) 8

1.3.5 ARTM Tier I (SOQPSK-TG) 8

1.3.6 ARTM Tier II (Multi-h CPM) 8

1.3.7 Legacy 8

1.3.8 RF Output Power 9

1.3.9 Packages 9

1.3.10 Automatic Carrier Wave Output Option – AC 10

1.3.11 Auto Carrier Save Option – ACS 10

1.3.12 Auxiliary Input Option – AI 10

1.3.13 Adapter Plate – AP 11

1.3.14 Baud Rate Option – BRx 11

1.3.15 CP07 Control Protocol Option – C7 11

1.3.16 Convolutional Encoder Option – CE 11

1.3.17 Clock-free Baseband Interface Option – CF 12

1.3.18 Clock Generator Output Option – CG 13

1.3.19 Dual Power Option – DP 13

1.3.20 Digital Switch Box Option – DSWBX 13

1.3.21 Ethernet Payload Capability – EN 13

1.3.22 Analog Frequency Modulation – FM 14

1.3.22.1	Using True Analog FM.....	14
1.3.23	Frequency Offset – FO.....	14
1.3.24	GPS Notch Option – GN	14
1.3.25	High Bit Rate Option – HR	14
1.3.26	Internal Clock and Data Option – ID.....	15
1.3.27	IN Frequency Band Option – IN	15
1.3.28	IN Frequency Band High Limit – INH	15
1.3.29	IN Frequency Band Low Limit – INL.....	15
1.3.30	Limited Current Option – LC.....	15
1.3.31	Forward Error Correction / Low Density Parity Check (LDPC) Option – LD	15
1.3.32	Forward Error Correction / Low Density Parity Check (LDPC) Option – LD6.....	15
1.3.33	Low Bit Rate Option – LR.....	16
1.3.34	Space Operations and Research S band Option – MA	16
1.3.35	Space Operations and Research S band High Limit Option – MAH.....	16
1.3.36	Space Operations and Research S band Low Limit Option – MAL	16
1.3.37	The standard Randomizer Control Option – MK.....	16
1.3.38	Modulation Scaling Option – MS.....	16
1.3.39	MDM-9 Accessory Board – P9.....	16
1.3.40	Parallel Port Frequency Programming Option – PF.....	17
1.3.41	Parallel Port Mode Selection Option – PM.....	17
1.3.42	Hardware Preset Option – PS (PS2, PS4, PS8, or PS16).....	17
1.3.43	Recall Holdoff Option – RH	17
1.3.44	Randomizer Output Option – RN	17
1.3.45	Spacecraft Tracking and Data Network Option – STDN.....	17
1.3.46	Variable FIFO Depth Option – VF	17
1.3.47	Variable Power Option – VP.....	17
1.3.48	Wide Input Voltage Range Option – WV	18

1.3.49	External Device Control – XD.....	18
2	Accessories.....	19
2.1	Bench Heat Sink (for ground applications only)	19
2.2	Airborne IntelliCool™ Heat Sink	20
2.3	Adapter Plate	22
2.4	Pre-wired MDM-15 for RS-422 Units.....	22
2.5	Pre-wired MDM-15 for TTL Units.....	23
2.6	MDM-15 Wiring Harness for RS-422 Units.....	23
2.7	MDM-15 Wiring Harness for TTL Units	24
2.8	USB to Serial Converter Cable.....	25
2.9	2 nd Generation Digital Switch Box	25
3	Installation Instructions	26
3.1	Mechanical.....	26
3.2	Thermal.....	28
3.3	Electrical	28
4	Operating Instructions.....	31
4.1	Power-on Operation.....	31
4.1.1	Dual Power via Hardware Control.....	31
4.1.2	2 nd Generation Switch Box Notes	31
4.2	TIMTER™ Serial Control Protocol.....	31
4.2.1	Command Set: Standard and Optional Commands.....	32
4.2.1.1	Additional Command Set Details	58
4.2.1.1.1	Automatic Carrier Output – AC.....	58
4.2.1.1.2	Baseband Clock – BBCK.....	58
4.2.1.1.3	Clock Free Bit Rate – BR	59
4.2.1.1.4	Baseband Interface Type - BT.....	61
4.2.1.1.5	Convolutional Encoder – CC	61
4.2.1.1.6	Clock Generator Source Select Command – CG.....	61
4.2.1.1.7	Frequency – FR	61
4.2.1.1.8	Internal Clock Rate – IC	62
4.2.1.1.9	Input Source Selection Command – IS	62
4.2.1.1.10	Low Density Parity Check (LDPC) Command – LD	65

4.2.1.1.11	Overtemperature Control – OC	66
4.2.1.1.12	RF Output – RF	67
4.2.1.1.13	RF Output State – RFS	67
4.2.1.1.14	Set Configuration Priority – SC.....	67
4.2.1.1.15	Frequency Sweep – SW.....	68
4.2.1.1.16	System Status Command – SY	69
4.2.1.1.17	External Device Control Command – XDC	70
4.2.1.1.18	External Device Channel Command – XDCH.....	71
4.2.1.1.19	External Device Frequency Switching Threshold Command – XDF.....	71
4.2.1.1.20	External Device Polarity Invert Command – XDP	72
5	RF Output Notes	73
5.1	Troubleshooting the RF on a Quasonix Transmitter	73
6	Performance Specifications	76
6.1	RF Output	76
6.2	Electrical Current	76
6.3	Environmental Specifications.....	77
6.3.1	EMI Performance.....	77
6.4	Carrier Frequency Tuning.....	78
6.5	Carrier Frequency Error.....	80
6.6	Bit Error Rate	80
6.7	Modulated RF Power Spectrum	81
6.8	Phase Noise Power Spectrum.....	83
6.9	Baseplate Temperature	84
6.10	Vibration and Shock.....	84
6.10.1	Vibration Testing.....	86
6.10.2	Shock Testing.....	89
7	Maintenance Instructions.....	93
8	Product Warranty	94
8.1	Quasonix Limited Warranty Statement.....	94
8.1.1	Extended Warranties.....	95
9	Technical Support and RMA Requests.....	96
10	Appendix A – Preset Option.....	97

11	Appendix B – Legacy Binary Protocol Notes	98
11.1	Known Limitations of Binary Protocol < V1.005	98
11.2	Items Not Supported By the Legacy Transmitter.....	98
12	Appendix C – Understanding Clock/Data, AC, and BR	99
13	Appendix D – Acronym List.....	101

List of Figures

Figure 1:	Quasonix Part Number Construction Description	1
Figure 2:	FPCM Signal on Oscilloscope	10
Figure 3:	CCSDS 131.0-B-1 Rendering of Basic Convolutional Encoder Diagram	12
Figure 4:	Bench Heat Sink and Power Supply	19
Figure 5:	Bench Heat Sink shown with 6 cubic inch TIMTER™	19
Figure 6:	Airborne IntelliCool™ Heat Sink, Pigtail Cable, SMA Extender, and Adapter Plate	20
Figure 7:	Airborne IntelliCool™ Heat Sink Mounted on an 04AB Package	21
Figure 8:	Airborne IntelliCool™ Heat Sink Mounted on a 07AE Package	21
Figure 9:	Close-up Using Female MDM-15 Connector.....	22
Figure 10:	Close-up Using Male MDM-15 Connector	22
Figure 11:	Adapter Plate	22
Figure 12:	Pre-wired MDM-15 with 36” Pigtails for RS-422.....	23
Figure 13:	Pre-wired MDM-15 with 36” Pigtails for TTL.....	23
Figure 14:	MDM-15 Socket Connector on an RS-422 Transmitter.....	24
Figure 15:	MDM-15 Cable Harness Used with RS-422 Transmitters	24
Figure 16:	MDM-15 Pin Connector on a TTL Transmitter	24
Figure 17:	MDM-15 Cable Harness Used with TTL Transmitters.....	24
Figure 18:	USB to Serial Converter Cable	25
Figure 19:	Digital Switch Box with 18” MDM-9 to MDM-9 Cable Harness.....	25
Figure 20:	4.2 in3 TIMTER™	26
Figure 21:	Outline Drawing, TIMTER™ 04AB Telemetry Transmitter	27
Figure 22:	Example Quasonix Pinout Drawing	29
Figure 23:	Baseband Signal Timing	30
Figure 24:	TIMTER™ Welcome Message	32
Figure 25:	PCM/FM (Tier 0) Power Spectral Density with Mask	82
Figure 26:	SOQPSK-TG (Tier I) Power Spectral Density with Mask	82

Figure 27: MULTI-h CPM (Tier II) Power Spectral Density with Mask 83

Figure 28: Phase Noise Limit Curve 84

Figure 29: Vibration / Shock Testing System 85

Figure 30: TIMTER™ Mounted for Z-axis Testing 85

Figure 31: TIMTER™ Mounted for X-axis Testing 86

Figure 32: TIMTER™ Mounted for Y-axis Testing 86

Figure 33: TIMTER™ Vibration Profile 86

Figure 34: Z-axis Vibration Spectrum 87

Figure 35: Y-axis Vibration Spectrum 88

Figure 36: X-axis Vibration Spectrum 88

Figure 37: Shock Pulse, Z-axis Positive 89

Figure 38: Shock Pulse, Z-axis Negative 90

Figure 39: Shock Pulse, Y-axis Positive 90

Figure 40: Shock Pulse, Y-axis Negative 91

Figure 41: Shock Pulse, X-axis Positive 91

Figure 42: Shock Pulse, X-axis Negative 92

Figure 43: Transmitter Clock and Data Logic 100

List of Tables

Table 1: Model Configuration Example 3

Table 2: Frequency Band Codes 4

Table 3: Clock and Data Interface Codes 6

Table 4: Serial Control Interface Codes 7

Table 5: ARTM Tier 0 Codes 8

Table 6: ARTM Tier I Codes 8

Table 7: ARTM Tier II Codes 8

Table 8: Legacy Codes 8

Table 9: RF Output Power Codes 9

Table 10: Package Codes 9

Table 11: Standard Data Bit Rates and Rate Adaptation Compared to Clock Free Data Bit Rates 13

Table 12: Standard Bit Rates Compared to Low/High Rate Options 15

Table 13: Standard and Optional User Commands 33

Table 14: DC Input Current at Standard Input Voltage 76

Table 15: TIMTER™ Environmental Specifications 77

Table 16: TIMTER™ EMI Compliance.....	77
Table 17: Carrier Frequencies (MHz)	78
Table 18: Transmitter BER Specifications with Quasonix Demodulator.....	80
Table 19: K and m Values per Waveform	81
Table 20: Random Vibration Spectrum.....	87
Table 21: Transmitter Priority of CS, CF, BR, and AC When RF is On.....	99

1 Introduction

1.1 Description

This document describes the Installation and Operation of Quasonix’ TIMTER™ Multi- mode Digital Telemetry Transmitters. The transmitters are designed to transmit airborne telemetry data from a test article to ground stations. The transmitters are developed, manufactured, and supported by:

Quasonix, Inc.
6025 Schumacher Park Drive
West Chester, OH 45069
CAGE code: 3CJA9

Refer to Appendix B for Legacy transmitter binary protocol information (binary protocol \leq V1.005).

1.2 Nomenclature

The earliest models of these transmitters were referred to as Tier I Missile Test Transmitters (TIMTER™) because they were intended for missiles and offered only ARTM Tier I (SOQPSK) modulation. Although the model line now includes much more than ARTM Tier I, and they are in widespread use on many platforms besides missiles, the “TIMTER” name remains. Now in its fourth generation, the transmitter is available in a number of variations, depending on the options specified at the time of order. It contains a faster processor, has improved frequency stability, and supports all six LDPC codes. The type of features and modes installed in each unit are identified in the model number, as depicted in Figure 1. Package field codes are listed in Table 10. For questions about specific packages, please contact Quasonix.

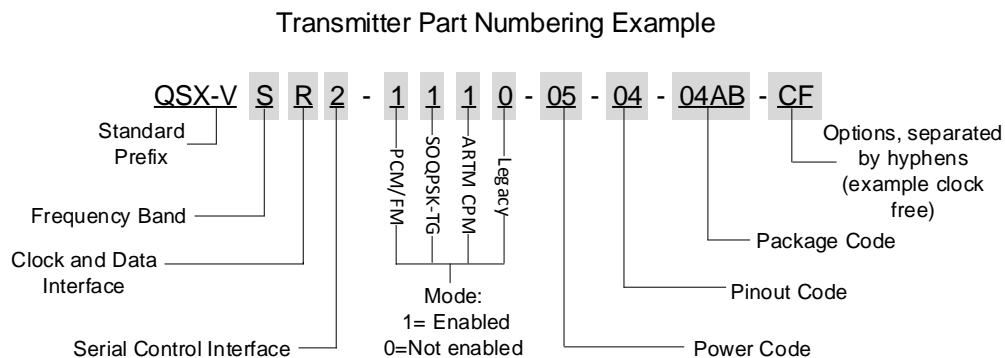

Figure 1: Quasonix Part Number Construction Description

In this manual, the words Terminal Control and Serial Control have the same meaning and are used synonymously throughout this manual. Serial control originates from configuring the transmitter from a computer’s legacy RS-232/422 serial communications (COM) port. Terminal Control reflects the more generic case where the transmitter could be controlled by other standard computer interfaces such as Ethernet.

The nanoTX and dual transmitter models are covered in separate user manuals, available for download from the company website: www.quasonix.com.

The available TIMTER™ software and hardware options are listed below. Refer to section 1.3 for detailed descriptions of each option.

- AC Automatic carrier wave output
- ACS Auto carrier save
- AI Auxiliary Input for digital data that is already premod filtered
- AP Adapter plate for 2.5" x 3.5" footprint – Include this hardware accessory with order
- BRx Request non standard baud rate for serial control
- C7 Quasonix interpretation of IRIG 106-17 Appendix 2-C serial control protocol
- CE Convolutional encoder (includes NRZ-M encoding) (k=7 rate 1/2)
- CF Clock-free baseband interface
- CG Clock generator output to baseband connector
- DP Dual power (Ability to set a low and a high setting, hardware controlled*)
- DSWBX Includes switch box and 18" MDM-9 to MDM-9 cable harness (For use with P9 option)
- EN Ethernet Payload Capability
- FM Allows the TIMTER™ to function as an analog FM transmitter
- FO Frequency Offset
- GN GPS notch filters to meet -147 dBm/Hz at L1 and L2
- HR Increases max bit rate up to 46 Mbps (23 Mbps for PCM/FM)
- ID Internal Clock and Data can be saved as a power-up default
- IN Inmarsat frequency band range
- INH Inmarsat frequency extended band high limit
- INL Inmarsat frequency extended band low limit
- LC Low current in the RF Off state, 10 mA (hardware option)
- LD LDPC forward error correction encoding
- LD6 Extended LDPC
- LR Decreases min bit rate to 50 kbps (25 kbps for PCM/FM)
- MA Below Lower S band (for Space Operations and Space Research applications)
- MAH Below Lower S band extended band high limit
- MAL Below Lower S band extended band low limit
- MK Randomizer hardware control – Include this hardware option with order
- MS Modulation scaling
- P9 MDM-9 Accessory board (use with switch box part QSX-AC-SWBX-P9-3B-3M)
- PF Parallel port frequency programming
- PM Parallel port mode selection
- PS Enable hardware presets (specify 2, 4, 8, or 16 – PS2, PS4, PS8, PS16)

- RH Recall Holdoff
- RN Randomizer output to baseband connector
- STDN Supports Spacecraft Tracking and Data Network (PM/BPSK) mode
- VF Variable FIFO Depth, controls transmitter latency
- VP Variable power (31 settings, spanning 24 dB), software controlled*
- WV Wide input voltage range
- XD External Device Control

Refer to Table 13 in section 4.2.1 for detailed descriptions of each option. Due to input connector pin count limitations, certain combinations of options are not available. Please contact Quasonix for support in ordering TIMTER™ options or for information regarding upgrades to TIMTER™ units that you may already own.

The model number identifies the configuration of the unit. For example, model number QSX-VSTT-1100-10-04-04AB-CF defines a unit configured as shown in Table 1.

Table 1: Model Configuration Example

Identifiers	Description
QSX	Quasonix product
V	Variable bit rate
S	S band code
T	TTL clock and data interface code
2	RS-232 serial control interface
1100	Tier 0 present, Tier I present, Tier II absent, Legacy absent
10	10 Watt RF output
04	Pinout code 04
04AB	Package code
CF	Clock-free baseband interface option

1.3 Part Number Field Codes

1.3.1 Frequency Bands

Frequency band codes are listed in Table 2. All frequency bands may be tuned 0.5 MHz above or below the stated frequency, except for units with the FO (frequency offset) option.

Table 2: Frequency Band Codes

Band ID Code	Band	Minimum Freq	Maximum Freq	Default Freq	Tuning Steps	Max Power
A	Lower S	2200.5 MHz	2300.5 MHz	2250.5 MHz	0.5 MHz	25 W
B	Mid C and Euro Mid C	5091.0 MHz 5150.0 MHz	5150.0 MHz 5250.0 MHz	5120.0 MHz	0.5 MHz	18 W
C	C “Low”	4400.0 MHz	4950.0 MHz	4620.0 MHz	0.5 MHz	18 W
D	C (with Mid C)	4400.0 MHz and 5091.0 MHz	4950.0 MHz and 5150.0 MHz	4620.0 MHz	0.5 MHz	18 W
E	(all) L, S, C	1435.5 MHz 1750.0 MHz 2200.5 MHz 2300.5 MHz 4400.0 MHz 5091.0 MHz 5150.0 MHz	1534.5 MHz 1855.0 MHz 2300.5 MHz 2394.5 MHz 4950.0 MHz 5150.0 MHz 5250.0 MHz	2370.5 MHz	0.5 MHz	10 W
F	S and C	2200.5 MHz and 4400.0 MHz	2394.5 MHz and 4950.0 MHz	2370.5 MHz	0.5 MHz	18 W
G	Euro Mid C	5150.0 MHz	5250.0 MHz	5150.0 MHz	0.5 MHz	18 W
H	L and C	1435.5 MHz and 4400.0 MHz	1534.5 MHz and 4950.0 MHz	1450.5 MHz	0.5 MHz	18 W
J	C, Mid C, and Euro Mid C	4400.0 MHz and 5091.0 MHz 5150.0 MHz	4950.0 MHz and 5150.0 MHz 5250.0 MHz	4620.0 MHz	0.5 MHz	18 W
K	S and C, Mid C, and (with Euro Mid C)	2200.5 MHz 4400.0 MHz and 5091.0 MHz 5150.0 MHz	2394.5 MHz 4950.0 MHz and 5150.0 MHz 5250.0 MHz	2370.5 MHz	0.5 MHz	10 W
L	Lower L	1435.5 MHz	1534.5 MHz	1450.5 MHz	0.5 MHz	20 W
M	Lower L, Upper L, and S	1435.5 MHz 1750.0 MHz and 2200.5 MHz	1534.5 MHz 1855.0 MHz and 2394.5 MHz	1450.5 MHz	0.5 MHz	20 W

Band ID Code	Band	Minimum Freq	Maximum Freq	Default Freq	Tuning Steps	Max Power
N	Upper S	2300.5 MHz	2394.5 MHz	2370.5 MHz	0.5 MHz	25 W
Q	L, S, and C	1435.5 MHz 1750.0 MHz 2200.5 MHz 4400.0 MHz 5091.0 MHz	1534.5 MHz 1855.0 MHz 2394.5 MHz 4950.0 MHz 5150.0 MHz	1450.5 MHz	0.5 MHz	10 W
S	S	2200.5 MHz	2394.5 MHz	2370.5 MHz	0.5 MHz	20 W
T	Lower L and C	1435.5 MHz 4400.0 MHz 5091.0 MHz	1534.5 MHz 4950.0 MHz 5150.0 MHz	1450.5 MHz	0.5 MHz	18 W
V	S and C (with Mid C)	2200.5 MHz 4400.0 MHz and 5091.0 MHz	2394.5 MHz 4950.0 MHz and 5150.0 MHz	2370.5 MHz	0.5 MHz	18 W
W	S, Mid C, and (with Euro Mid C)	2200.5 MHz 5091.0 MHz 5150.0 MHz	2394.5 MHz 5150.0 MHz 5250.0 MHz	2370.5 MHz	0.5 MHz	18 W
X	Mid C band	5091.0 MHz	5150.0 MHz	5120.0 MHz	0.5 MHz	18 W
Y	L and C	1435.5 MHz 1750.0 MHz and 4400.0 MHz 5091.0 MHz	1534.5 MHz 1855.0 MHz and 4950.0 MHz 5150.0 MHz	1450.5 MHz	0.5 MHz	18 W
Z	Lower L, Mid C, and Euro Mid C	1435.5 MHz 5091.0 MHz and 5150.0 MHz	1534.5 MHz 5150.0 MHz and 5250.0 MHz	1450.5 MHz	0.5 MHz	18 W

*Note: Currently the MA option enables operation below Lower S band frequencies in the tuning range of 2025.0 MHz to 2110.0 MHz for use in Space operations and Space research. Refer to the MA option in section 1.3.34 for additional information or contact Quasonix.

1.3.2 Clock and Data Interface

Clock and data interface codes are listed in Table 3.

Table 3: Clock and Data Interface Codes

Clock and Data Interface Code	Baseband Clock and Data Interface	Defaults
H	TTL – 10k ohms to ground	TTL 10k ohms
T	TTL – 75 ohms to ground	TTL 75 ohms
A	TTL – Selectable between 75 ohms to ground and 10k ohms to ground	TTL 75 ohms
R	TIA/EIA-422 (RS-422) – 120 ohms differential	422 120 ohms
B	TIA/EIA-422 (RS-422) – 120 ohms differential, even when unit is powered off	422 120 ohms
M	Dual-mode – Selectable between TTL (terminated 10k ohms to ground) and RS-422 (terminated 120 ohms differential)	422 10k ohms
D	Dual-mode – Selectable between TTL (terminated 75 ohms to ground) and RS-422 (terminated 120 ohms differential)	422 75 ohms
S	Tri-mode – Selectable between TTL (terminated 75 ohms to ground), TTL (terminated 10k ohms to ground), and RS-422 (terminated 120 ohms differential)	422 75 ohms
L	LVDS (Low Voltage Differential Signal)	LVDS

1.3.3 Serial Control Interface

Serial control interface codes are listed in Table 4.

Table 4: Serial Control Interface Codes

Serial Control Interface Code	Serial Control Interface
2	RS-232
T	TTL
4	RS-422
6	RS-422, 120 ohms differential, even when unit is powered off

1.3.4 ARTM Tier 0 (PCM/FM)

ARTM Tier 0 codes are listed in Table 5.

Table 5: ARTM Tier 0 Codes

Part Number Code	PCM/FM (ARTM Tier 0)
0	Absent
1	Present

1.3.5 ARTM Tier I (SOQPSK-TG)

ARTM Tier I codes are listed in Table 6.

Table 6: ARTM Tier I Codes

Part Number Code	SOQPSK-TG (ARTM Tier I)
0	Absent
1	Present

1.3.6 ARTM Tier II (Multi-h CPM)

ARTM Tier II codes are listed in Table 7.

Table 7: ARTM Tier II Codes

Part Number Code	Multi-h CPM (ARTM Tier II)
0	Absent
1	Present

1.3.7 Legacy

Legacy modes include BPSK, QPSK, and OQPSK. Legacy codes are listed in Table 8.

Table 8: Legacy Codes

Part Number Code	Legacy Modes
0	Absent
1	Present

1.3.8 RF Output Power

RF output power codes are listed in Table 9.

Table 9: RF Output Power Codes

Part Number Code	RF Output Power
00	10 mW (+10 dBm), ±1 dB
01	1 watt (+30 dBm), minimum
02	2 watt (+33 dBm), minimum
05	5 watts (+37 dBm), minimum
10	10 watts (+40 dBm), minimum
18	18 watts (+42.5 dBm), minimum
20	20 watts (+43 dBm), minimum
25	25 watts (+44 dBm), minimum

1.3.9 Packages

Package field codes are listed in Table 10. Detailed information for packages other than 04AB is located in the TIMTER™ Transmitter Packages document, available at the Quasonix web site. For questions about specific packages, please contact Quasonix.

Table 10: Package Codes

TIMTER™ Package	Volume	Width	Length	Height
02XX	1.992 in ³	2.000"	3.000"	0.332"
04XX	4.200 in ³	2.000"	3.000"	0.700"
05XX	4.800 in ³	2.000"	3.000"	0.800"
06XX	6.072 in ³	2.000"	3.000"	1.012"
07XX	6.546 in ³	2.000"	3.000"	1.091"
	6.672 in ³	2.000"	3.000"	1.112"
08XX	7.590 in ³	2.200"	3.450"	1.000"
	8.418 in ³	2.000"	3.450"	1.403"
09XX	9.180 in ³	2.000"	3.000"	1.530"

*Package dimensions do not include connectors

Transmitter weight may vary depending on packages and applications. For information about the weight of a particular transmitter, please contact Quasonix.

1.3.10 Automatic Carrier Wave Output Option – AC

This option allows the TIMTER to transmit a carrier wave when the clock input is absent, which would normally cause the RF output to be turned off.

1.3.11 Auto Carrier Save Option – ACS

This option allows the TIMTER to transmit a carrier wave when the clock input is absent, which would normally cause the RF output to be turned off, just like the AC option. ACS uses the saved setting of AC on power up instead of forcing AC on like the legacy option.

1.3.12 Auxiliary Input Option – AI

The AI option provides an auxiliary input that allows the TIMTER™ to transmit Filtered PCM (FPCM) data. FPCM is a binary data waveform that has been filtered such that the data transitions are slowed down. The FPCM signal at the TIMTER, viewed on an oscilloscope, might look something like the following figure.

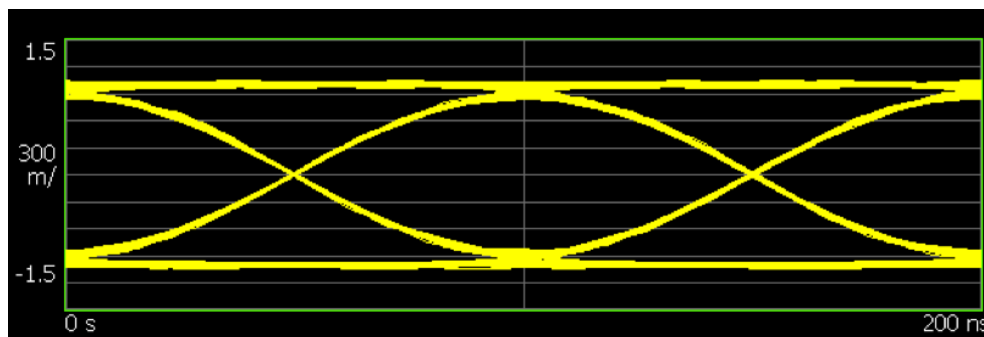

Figure 2: FPCM Signal on Oscilloscope

The AI option allows the TIMTER™ to replace a legacy analog transmitter, but only for use in transmitting a digital data stream. **Refer to the FM option in section 1.3.23 for configuring the TIMTER™ to transmit a true analog signal, such as NTSC video.** The AI option is frequently used to interface the TIMTER™ to legacy encryption devices, which often include filtering on their outputs, including a DC blocking capacitor. By default, the Auxiliary Input is configured to accept an AC-coupled input. The AIR command may be used to select between a zero and a non-zero DC bias.

The auxiliary input converts the FPCM input back to an unfiltered bit stream, locks an internal bit sync to that bit stream (refer to the CF option), and then modulates the transmitter based on that digital bit stream, in which case the deviation and the internal premod filter bandwidth are set by the bit rate, and are independent of the analog voltage levels presented to the transmitter.

Use of the auxiliary input requires the –AI option. The command for controlling auxiliary input is AI, which enables/disables the auxiliary input (when disabled, the normal digital input is used). Since there is no clock input, the Clock Free option (CF) is required. (Refer to section 1.3.15 for more information about Clock Free.)

To configure the TIMTER™ for use with the Auxiliary Input, issue the following commands:

AI = 1 (get data stream from Auxiliary Input)

CF = 0 (operate clock free)

BR xxx, where xxx = data rate in Mbps, or BR A for automatic data rate

AIR x, where x = 0 for zero DC bias and x = 1 for 1.65V DC bias

1.3.13 Adapter Plate – AP

Use this option to include the 2.5” x 3.5” adapter plate (hardware accessory) with the order.

1.3.14 Baud Rate Option – BRx

The BR option changes the serial communications default baud rate on the transmitter to the one selected. A number from 0-8 follows the BR option request. Corresponding values are as follows: 0 = 57600 (Standard default for all Quasonix transmitters); 1 = 4800; 2 = 9600; 3 = 19200; 4 = 38400; 5 = 56000; 6 = 57600; 7 = 115200; 8 = 230400.

1.3.15 CP07 Control Protocol Option – C7

The Quasonix interpretation of IRIG 106-17, Appendix 2-C serial control protocol (CP07), “provides standards for commands, queries, and status information when communicating with telemetry transmitters configured with communication ports.” The Basic command set contains the minimum (required) commands for transmitter control, query, and status. The Extended command set contains optional commands that may or may not be implemented at the manufacturer’s discretion. CP07 is enabled when the C7 option is requested.

The default baud rate for CP07 transmitters is 9600.

1.3.16 Convolutional Encoder Option – CE

The CE option enables convolutional encoding and NRZ-M conversion. This encoding adds redundant information to the transmitted data stream to help detect and correct bit errors that may occur, particularly due to predominantly Gaussian noise. Use of convolutional encoding requires a matching Viterbi decoder in the receiver to extract the source data. The encoded data rate will be twice the source data rate, and the occupied bandwidth will also be doubled.

For example, the transmitter has two encoders, one for in-phase (“I”) data and one for quadrature (“Q”) data. Call the input symbol stream I0/Q0, I1/Q1, Each encoder outputs 2 bits for every input bit, so call the output bit stream from the first convolutional encoder I0(1), I0(2), I1(1), I1(2), ... , and call the output bit stream from the second convolutional encoder Q0(1), Q0(2), Q1(1), Q1(2), Combining the outputs of the two encoders, then, the output symbol stream is I0(1)/Q0(1), I0(2)/Q0(2), I1(1)/Q1(1), I1(2)/Q1(2),

For modes that do not employ Quadrature modulation, such as PCM/FM, Multi-h CPM, and BPSK, only a single encoder is used.

A single encoder is implemented exactly as described in the “Consultative Committee for Space Data Systems, Recommendation for Space Data System Standards, TM Synchronization and Channel Coding, CCSDS 131.0-B-1, Blue Book, September 2003, Section 3.”

A basic convolutional encoder block diagram, as illustrated in CCSDS 131.0-B1, is shown in Figure 3.

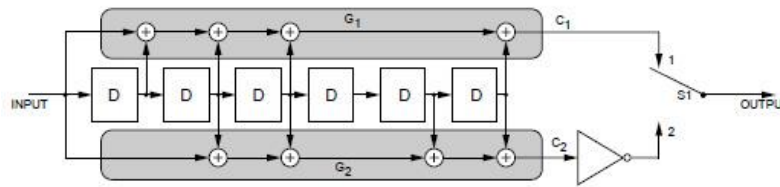

NOTES:



1.  = SINGLE BIT DELAY.
2. FOR EVERY INPUT BIT, TWO SYMBOLS ARE GENERATED BY COMPLETION OF A CYCLE FOR S1: POSITION 1, POSITION 2.
3. S1 IS IN THE POSITION SHOWN (1) FOR THE FIRST SYMBOL ASSOCIATED WITH AN INCOMING BIT.
4. \oplus = MODULO-2 ADDER.
5.  = INVERTER.

Figure 3-1: Basic Convolutional Encoder Block Diagram

*Consultative Committee for Space Data Systems, Recommendation for Space Data System Standards, TM Synchronization and Channel Coding, CCSDS 131.0-B-1, Blue Book, September, 2003," page 3-2.

Figure 3: CCSDS 131.0-B-1 Rendering of Basic Convolutional Encoder Diagram

1.3.17 Clock-free Baseband Interface Option – CF

Clock-free is an optional mode that transmits user data, but uses an internal bit sync to take the place of the normal external clock. The standard TIMTER requires external clock and data inputs. With the CF option, no external clock is required. The clock is generated directly from the data and a user-specified bit rate.

Because the internal bit sync's clock takes the place of the normal external clock in clock-free mode, the selected clock source must be external for clock-free just like it is for normal clock/data. This mode is most often used to retrofit older analog transmitters in TM systems where the crypto device does not deliver a clock to the transmitter.

The commanded clock-free rate can be saved with the SV command, and if so, it will be restored at power-on. When the CF option is used, the bit rate range is as defined in Table 12 for all waveform modes. It is limited by the bit rate achievable for the current mode. (Refer also to the HR and LR options for extended bit rates, the ID option for Internal Clock and Data, and Table 11 for a snapshot of bit rate information.)

Do not confuse the **CF option** with **CS/DS commands**.

Internal clock (CS 1 Command) is used when the transmitter is to be a test source only. The unit transmits the selected internal data pattern (DS 1 command) at the bit rate set by the user via the IC command. The internal clock is not used to transmit actual payload data.

External clock (CS 0 Command) is the normal mode: the user supplies clock and data, or in clock-free mode, the user only supplies valid data. Refer to Table 13 for user commands.

Table 11: Standard Data Bit Rates and Rate Adaptation Compared to Clock Free Data Bit Rates

<p>Data (bit) rate, automatic rate adaptation</p>	<p>TIMTER: 0.1-28 Mbps (0.05-14 Mbps for PCM/FM) TIMTER <i>option</i> HR: Extends upper limit to max of 46 Mbps for SOQPSK and ARTM CPM (23 Mbps for PCM/FM) TIMTER <i>option</i> LR: Extends lower limit to min of 50 kbps for SOQPSK and ARTM CPM (25 kbps for PCM/FM)</p>
<p>Clock Free Data (bit) rate</p>	<p>With BR x command: Allows user to enter a fixed bit rate in the range defined in the Data (bit) rate specifications above With BR A command: Automatically detects bit rate in the range defined in The Data (bit) rate specifications above; Quasonix guarantees automatic bit rate operation up to 35 Mbps; beyond that operation is dependent on input data signal quality (jitter, truly random data, etc.)</p>

1.3.18 Clock Generator Output Option – CG

The standard TIMTER includes internal clock and data generators, generally used for system test. The CG option enables this internal clock out of the unit on the primary MDM-15 connector. The assignment of output pins depends on the other features selected.

1.3.19 Dual Power Option – DP

The standard TIMTER operates at its full rated RF output power. The DP option provides two software-programmed, hardware-actuated settings, designated by the user as “high power” and “low power”. There are 32 choices for “high power” and 32 choices for “low power”. The low power setting can provide as much as 24 dB of attenuation from the high power setting.

1.3.20 Digital Switch Box Option – DSWBX

The TIMTER™ provides a standard configuration interface that is easily accessible via a computer terminal. Some users prefer configuration via an external switch box. The 2nd Generation Quasonix switch box provides six LED digits used to display the mode and frequency. This includes a total of five digits of frequency step up or down, in MHz, and one digit of mode selection, in terms of the ARTM “Tier” number. There is also a channel selector for channel 1 or channel 2. Two channel operation is only valid when connected to a Dual Telemetry Transmitter. Standard transmitters default to Channel 1. An 18” MDM-9 to MDM-9 cable harness is included with the switch box. (For use with the P9 option)

1.3.21 Ethernet Payload Capability – EN

The –EN option gives the transmitter the ability to send Ethernet data via direct connection to a standard Ethernet network. Operating in Ethernet mode, the user sets the desired transmission rate through the transmitter control interface. As Ethernet data are presented to the TIMTER, they are loaded into a large transmit buffer. If the presented Ethernet traffic does not keep the buffer filled, bit stuffing is used to attain the programmed transmit rate. If the presented traffic overflows the buffer, Ethernet data are discarded.

The Ethernet interface is supported via an MDM-9 connector, and is compatible with 10Base-T and 100Base-TX Ethernet physical layers. The maximum transmission rate is 46 Mbps. Use of a transmitter with the –EN option requires a Quasonix RDMS™ receiver to reconstruct the Ethernet data at the receive end.

Pre-assembled MDM-9 Male to RJ-45 (T568A standard) cables are available from Molex:

- 83421-9224 Micro-D 9 to RJ-45 (T568A standard), 1.2m
- 83421-9225 Micro-D 9 to RJ-45 (T568A standard), 10.0m
- 83421-9226 Micro-D 9 to RJ-45 (T568A standard), 3.0m

1.3.22 Analog Frequency Modulation – FM

This option allows the TIMTER™ to function as an analog FM transmitter. In this mode, the analog input voltage is converted to frequency offset, relative to the carrier, based on a settable deviation scale factor. No filtering or other signal processing is performed, and commands and functions related to digital clock/data do not affect the modulated output. This mode of operation is designed for use with a true analog signal, such as NTSC video. By default, the analog FM input is AC coupled, with a low frequency cutoff of less than 15 Hz. Contact Quasonix if you need a DC coupled analog input.

FM mode is not optimal for sending digital data; refer to the AI option in section 1.3.11 for that configuration. However, if your TIMTER™ has only the FM option, and not the AI option, you can still use it to transmit digital data, but you will not have the greatest benefit of the AI option: the internal bit sync is not available to set the internal premod filter and deviation automatically. When using the FM mode to send digital data, the premod filtering must be performed externally, and the deviation is set using the AFMS command (refer to section 1.3.22.1).

1.3.22.1 Using True Analog FM

Analog FM provides the capability of frequency modulating the RF carrier based on an analog input signal voltage, making the Quasonix digital transmitter behave virtually identically to an analog PCM/FM transmitter (but with improved phase noise, more precise deviation control, etc.). Analog FM requires the –FM option. The two commands for controlling analog FM are MO and AFMS. MO 12 enables the analog FM input, and AFMS sets the sets the deviation in MHz per Volt. (Refer to the Command Set section 4.2.1, for specific information about each command.)

In order to use TRUE analog FM:

- The –FM option must be in the part number
- Mode must be set to MO 12
- Use AFMS xx command to set the deviation sensitivity to xx MHz / volt; for example AFMS 1.0

Refer also to the Auxiliary Input option, section 1.3.11.

1.3.23 Frequency Offset – FO

This option is used to set frequencies that are NOT aligned to the synthesizer step size for their units, typically 500 kHz. If the FO option is present, the resolution is 1 Hz (0.000001 MHz). The desired offset may be typed with the frequency using the FR command.

1.3.24 GPS Notch Option – GN

Use this option to specify GPS notch filters to meet -147 dBm/Hz at L1 and L2. This option is not available on transmitters that can tune to L band (band codes E, H, L, M, Q, T, Y, and Z). Note that certain combinations of frequency band and power level, 5 Watt C band for example, include the GPS notch filters by default. However, the GN option provides a specification guarantee that the noise in the GPS bands is below -147 dBm/Hz and includes measured data on each unit.

1.3.25 High Bit Rate Option – HR

The standard TIMTER supports bit rates from 0.1 to 28 Mbps in SOQPSK-TG and ARTM CPM modes, 0.05 to 14 Mbps in PCM/FM (Tier 0) mode and in all legacy modes. The HR option increases the bit rate to a maximum of 46 Mbps (23 Mbps for PCM/FM). Refer to the CF option for information about the Clock Free option.

Refer to Table 12 for bit rate comparisons by mode.

Table 12: Standard Bit Rates Compared to Low/High Rate Options

	Standard Bit Rate	With Low Rate Option –LR	With High Rate Option –HR*
ARTM Tier 0 Modulation (PCM/FM)	0.05 -14 Mbps	Down to 0.025 Mbps	Up to 23 Mbps
ARTM Tier I Modulation (SOQPSK-TG)	0.1 – 28 Mbps	Down to 0.050 Mbps	Up to 46 Mbps
ARTM Tier II Modulation (Multi-h CPM)	0.1 – 28 Mbps	Down to 0.050 Mbps	Up to 46 Mbps
Legacy Modulation (BPSK)	0.05 – 10 Mbps	N/A	N/A
Legacy (QPSK, OQPSK)	0.05 – 20 Mbps	N/A	N/A

*Maximum data rates on Quasonix transmitters are limited by the equipment used to test the transmitter. Experiments and simulations suggest that the transmitters can generate “high fidelity” PCM/FM up to about 40 Mbps, and SOQPSK and ARTM CPM up to about 80 Mbps. However, our test station demodulators cannot run above the specified 23 Mbps and 46 Mbps rates, so performance above those rates is unspecified.

1.3.26 Internal Clock and Data Option – ID

The ID option allows the CS and DS user settings to be reloaded on power up or on a manual recall of a setup. Without the ID option, CS and DS are both forced to 0. Refer to the CF option for information about the Clock Free option.

1.3.27 IN Frequency Band Option – IN

This option sets the frequency band range to 1625.5 MHz to 1675.5 MHz.

1.3.28 IN Frequency Band High Limit – INH

This option extends the upper IN band frequency to the frequency listed with the option, in MHz, such as INHxxxx. Limit must be within roughly 100 MHz of the band range.

1.3.29 IN Frequency Band Low Limit – INL

This option extends the lower IN band frequency to the frequency listed with the option, in MHz, such as INLxxxx. Limit must be within roughly 100 MHz of the band range.

1.3.30 Limited Current Option – LC

This option is used to specify low current in the RF Off state. Current draw is less than 10 mA when the transmitter is Off. This is a hardware option.

1.3.31 Forward Error Correction / Low Density Parity Check (LDPC) Option – LD

This option provides the Low Density Parity Check (LDPC) encoding, which is being considered for use on the iNET program. LDPC has been adopted by the Range Commander’s Council, IRIG 106-17, Appendix 2-D.

1.3.32 Forward Error Correction / Low Density Parity Check (LDPC) Option – LD6

This option adds the extended LDPC option to the unit. It lets the user select from the six implemented LDPC codes, and allows the randomizer command to select the CCSDS randomizer, if LDPC is enabled. Adding this option automatically enables the existing LD option.

The IRIG standard calls out six variants of LDPC codes—all combinations of two different information block sizes (k=4096 bits and k=1024 bits) and three different code rates (r=1/2, r=2/3, and r=4/5).

K=4096, r=1/2

k=1024, r=1/2

k=4096, r=2/3

k=1024, r=2/3

k=4096, r=4/5

k=1024, r=4/5

1.3.33 Low Bit Rate Option – LR

The standard TIMTER™ supports bit rates from 0.1 to 28 Mbps in SOQPSK-TG and ARTM CPM modes, 0.05 to 14 Mbps in PCM/FM (Tier 0) mode and in all legacy modes. The LR option decreases the bit rate to a minimum of 50 kbps (25 kbps for PCM/FM). Refer to the CF option for information about the Clock Free option.

Refer to Table 12 for bit rate comparisons by mode.

1.3.34 Space Operations and Research S band Option – MA

This option enables frequencies below Lower S band (generally used for Space operations and Space research applications). The frequency range is 2025.0 MHz to 2110.0 MHz with a default frequency of 2050.5 MHz in 0.5 MHz tuning steps. Maximum power currently allowed is 10 W.

1.3.35 Space Operations and Research S band High Limit Option – MAH

This option extends the upper MA band frequency to the frequency which follows this option, in MHz, such as MAHxxxx. Limit must be within roughly 100 MHz of band range.

1.3.36 Space Operations and Research S band Low Limit Option – MAL

This option extends the lower MA band frequency to the frequency which follows this option, in MHz, such as MALxxxx. Limit must be within roughly 100 MHz of band range.

1.3.37 The standard Randomizer Control Option – MK

The standard TIMTER™ provides a user command (RA) that reports or sets the randomizer state. This option enables ON/OFF control of the randomizer with a hardware pin. Use this option to specify the Randomizer Control (hardware configuration) with the order.

1.3.38 Modulation Scaling Option – MS

This option enables the MS command which allows a user to scale the modulation index of the transmitted signal. For additional information, refer to Table 13, or contact Quasonix.

1.3.39 MDM-9 Accessory Board – P9

Use this option to include the MDM-9 Accessory Board (sometimes referred to as a “tophat board”) (hardware accessory), for use with switch box part number QSX-AC-SWBX-P9-3B-3M, with the order.

1.3.40 Parallel Port Frequency Programming Option – PF

This option adds a parallel port in the form of an MDM-15 connector for manual frequency tuning. The PF option requires the addition of a Quasonix MDM-9 Accessory Board. Consult Quasonix to order the PF option.

1.3.41 Parallel Port Mode Selection Option – PM

This option adds a parallel port in the form of an MDM-15 connector for manual mode selection. The PM option requires the addition of a Quasonix MDM-9 Accessory Board. Consult Quasonix to order the PM option.

1.3.42 Hardware Preset Option – PS (PS2, PS4, PS8, or PS16)

The TIMTER™ supports one or more hardware presets. A single preset defines the complete state of the transmitter, including carrier frequency, modulation mode, data polarity, randomizer state, etc. Without the PS option, the TIMTER™ supports only one hardware preset, which it reverts to at power-up. The PS in the option string specifies that the unit supports multiple hardware presets (2, 4, 8, or 16). Presets are engaged by grounding various combinations of pins on the terminal/parallel control selection. The number of presets available and which pins engage the presets depend on the other features specified. Due to the limited number of pins available, the PS option may require the elimination of the RF On/Off pin. Due to firmware part number parsing requirements, the hardware preset option code must be at the very end of the part number to be valid. On units which use the standard MDM-15 connector, the ZY command displays the connector pinout showing preset pin locations. For additional information, refer to Appendix A – Preset Option.

1.3.43 Recall Holdoff Option – RH

If this option is enabled, AND the recall holdoff pin is held low on powerup, THEN the software will do an ‘RF 0’ to prevent the RF output from coming on until the user explicitly enters ‘RF 1.’ If the pin is high, then this option has no effect.

1.3.44 Randomizer Output Option – RN

The standard TIMTER includes the IRIG-106 randomizer for the RF output. The IRIG-106 randomizer is controlled through the serial interface. The RN option brings the randomized data out on the primary MDM-15 connector. The assignment of output pins depends on the other features selected. Consult Quasonix for details.

1.3.45 Spacecraft Tracking and Data Network Option – STDN

This option supports the PM/BPSK mode (Spacecraft Tracking and Data Network mode).

1.3.46 Variable FIFO Depth Option – VF

This option enables the VF command which allows the user to set the FIFO depth on the transmitter for controlling latency time between bits in and bits out. The range is 0 to 255 with 128 being the default. If no value is entered, the current value displays.

1.3.47 Variable Power Option – VP

The standard TIMTER™ operates at its full rated RF output power. The software-based VP option provides 64 discrete power level settings, approximately 0.5 dB apart. For TIMTER packages of 2 cubic inches or less, the VP option provides 32 discrete power level settings, approximately 1.0 dB apart.

1.3.48 Wide Input Voltage Range Option – WV

The standard TIMTER™ operates from $+28 \pm 4$ VDC. The WV option extends operating input voltage range as shown in following table.

Voltage Ranges with WV Option	Available Bands
+8.0 to +34 VDC for 10 mWatt version	All band combinations are available at this power level.
+8.0 to +34 VDC for 1 Watt version	All band combinations are available at this power level.
+8.0 to +34 VDC for 2 Watt version	All band combinations are available at this power level.
+12 to +34 VDC for 5 Watt version	All band combinations are available at this power level.
+21 to +34 VDC for 10 Watt version	All band combinations except <i>band codes F, H, K, Q, V, T, W, Y, and Z</i>
+24 to +34 VDC for 18 Watt version	Band codes A, L, N, S, and M
+24 to +34 VDC for 20 Watt version	Band codes A, L, N, S, and M
+24 to +34 VDC for 25 Watt version	Band codes A and N

1.3.49 External Device Control – XD

This option lets the user control the state and operation of the new TTL output pins on the switchbox interface connector. Refer to section 4.2.1 for command descriptions.

2 Accessories

Quasonix offers a number of optional accessories for TIMTER™, including a fan-cooled, bench heat sink, a 2.5” x 3.5” adapter plate, pre-wired mating MDM-15 connectors, complete MDM-15 cable assemblies, a ruggedized handheld programmer, and a USB to serial converter cable. Regardless of the heat sink, Quasonix strongly suggests using a thermal pad, such as Q-Pad® II from Bergquist. Refer to section 3.2, for additional thermal information.

Contact Quasonix for pricing and availability of TIMTER™ accessories.

2.1 Bench Heat Sink (for ground applications only)

Part Number: QSX-AC-32-HS-12V

The heat sink assembly includes an integral +12 VDC fan and a power supply transformer, shown in Figure 4. The heat sink is shown with a mounted 6 cubic inch TIMTER™ in Figure 5.



Figure 4: Bench Heat Sink and Power Supply



Figure 5: Bench Heat Sink shown with 6 cubic inch TIMTER™

2.2 Airborne IntelliCool™ Heat Sink

Part Number: (QSX-AC-32-HS-28V-SP)

The heat sink assembly includes an integral +12 VDC fan, power supply, and temperature-controlled power on at +37°C. Fan speed is regulated to compensate for changes in air pressure/density under high altitude conditions. Two MDM-15 connectors and a provided pigtail cable, shown in Figure 6, allow the heat sink to draw power directly from a TIMTER™ transmitter eliminating the need for a separate external power supply. An adapter plate is also included with the heat sink.

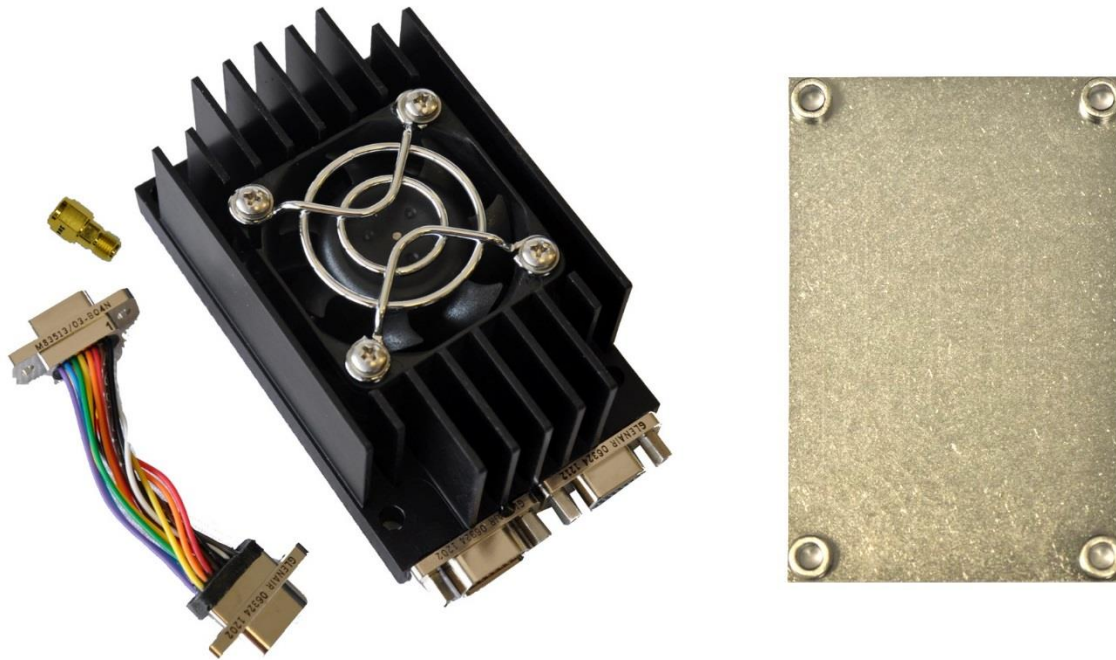

Figure 6: Airborne IntelliCool™ Heat Sink, Pigtail Cable, SMA Extender, and Adapter Plate

The heat sink is shown mounted on a standard 04AB TIMTER™ in Figure 7 and mounted on a larger 07AE TIMTER™ in Figure 8. The pigtail cable connects to any TIMTER™, regardless of MDM-15 gender, by plugging the pigtail into either the male or female connector, as shown in Figure 9 and Figure 10.

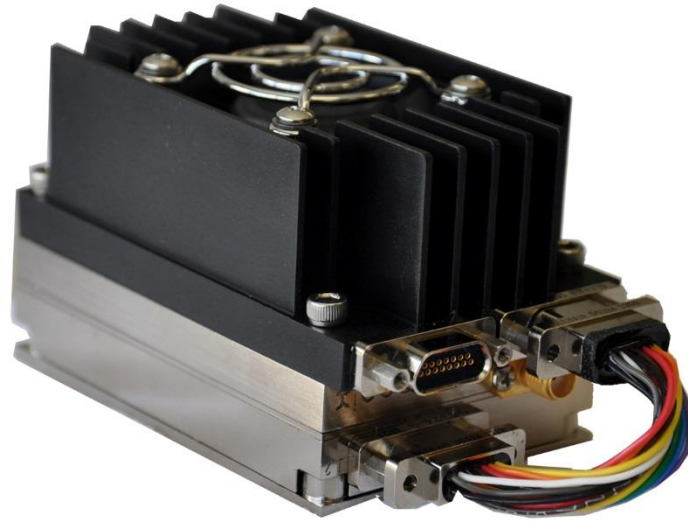

Figure 7: Airborne IntelliCool™ Heat Sink Mounted on an 04AB Package

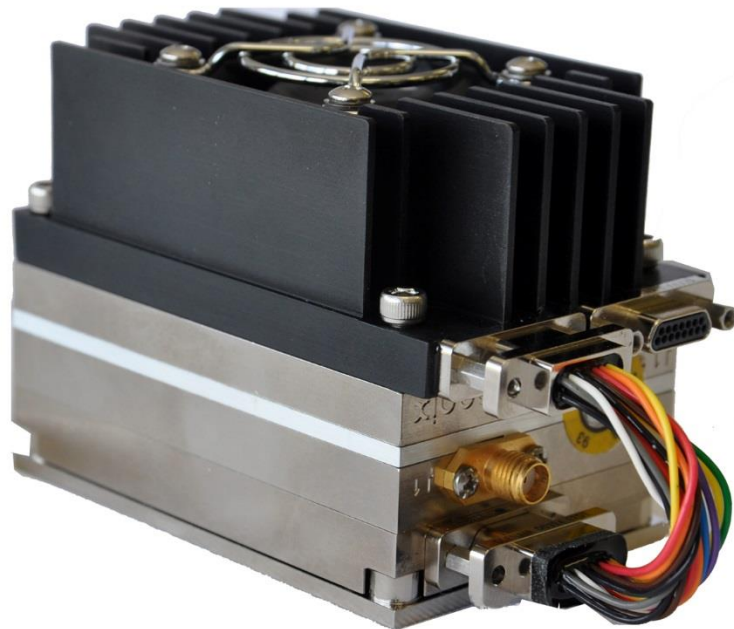

Figure 8: Airborne IntelliCool™ Heat Sink Mounted on a 07AE Package



Figure 9: Close-up Using Female MDM-15 Connector



Figure 10: Close-up Using Male MDM-15 Connector

2.3 Adapter Plate

Part Number: QSX-AC-AP-96

The adapter plate, shown in Figure 11, allows for the standard 2" x 3" footprint TIMTER™ to be mounted to the larger 2.5" x 3.5" mounting surface occupied by other industry transmitters. Note, this adapter plate is not used with the Airborne IntelliCool™ Heat Sink. The appropriate adapter plate is included in the kit.



Figure 11: Adapter Plate

2.4 Pre-wired MDM-15 for RS-422 Units

Part Number: QSX-AC-MDM15-36-PIN

An MDM-15 connector with 36" color-coded pigtail cables for connecting to transmitters with the RS-422 clock and data baseband interface is shown in Figure 12.

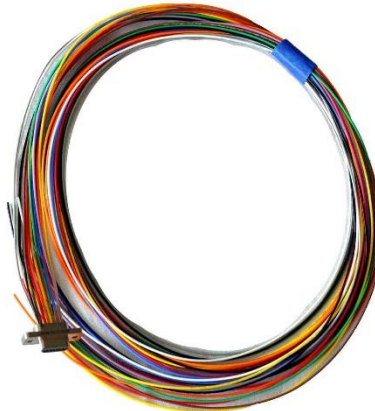

Figure 12: Pre-wired MDM-15 with 36” Pigtails for RS-422

2.5 Pre-wired MDM-15 for TTL Units

Part Number: QSX-AC-MDM15-36-SOCK

Quasonix offers an MDM-15 connector with 36” color-coded pigtail cables for connecting to transmitters with the TTL clock and data baseband interface.



Figure 13: Pre-wired MDM-15 with 36” Pigtails for TTL

2.6 MDM-15 Wiring Harness for RS-422 Units

Part Number: QSX-AC-MDM15-HARNESS-PIN

An MDM-15 wiring harness for connecting to transmitters with RS-422 clock and data baseband interface is shown in Figure 15. It includes banana plugs for power and ground, BNC connectors for clock and data, and a DB-9 connector for serial control and is 35 to 36 inches long depending on the connectors.

Figure 14 shows the MDM-15 socket connector installed on RS-422 transmitters.

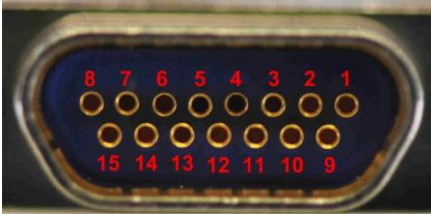

Figure 14: MDM-15 Socket Connector on an RS-422 Transmitter



Figure 15: MDM-15 Cable Harness Used with RS-422 Transmitters

2.7 MDM-15 Wiring Harness for TTL Units

Part Number: QSX-AC-MDM15-HARNESS-SOCK

Quasonix offers an MDM-15 wiring harness for connecting to transmitters with TTL clock and data baseband interface, as shown in Figure 17. It includes banana plugs for power and ground, BNC connectors for clock and data, and a DB-9 connector for serial control and is 35 to 36 inches long depending on the connectors.

Figure 16 shows the MDM-15 pin connector installed on TTL transmitters.

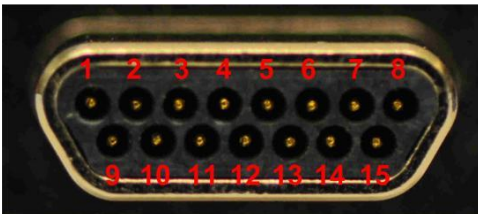

Figure 16: MDM-15 Pin Connector on a TTL Transmitter



Figure 17: MDM-15 Cable Harness Used with TTL Transmitters

2.8 USB to Serial Converter Cable

Part Number: QSX-AC-USBSER-CONV

The 36 inch long USB to serial converter cable allows for configuration of the transmitter with a computer that does not have a serial port. The cable is pictured in Figure 18. An 18 inch long cable is also available.



Figure 18: USB to Serial Converter Cable

2.9 2nd Generation Digital Switch Box

Part Number: QSX-AC-DSWBX

This accessory enables configuration of a TIMTER™ via an external digital switch box. Six LED digits are used to display the mode and frequency. A channel selector for channel 1 or channel 2 enables operation with a Quasonix Dual Telemetry Transmitter. Standard transmitters default to channel 1. Included with the switch box is an 18” MDM-9 to MDM-9 cable harness. The switch box and cable harness is pictured in Figure 19.

The transmitter which will use the switch box requires the P9 option when ordering to ensure an MDM-9 port is installed.

If you already own a Quasonix transmitter with an old switch box, the digital switch box can be swapped for the old one seamlessly.

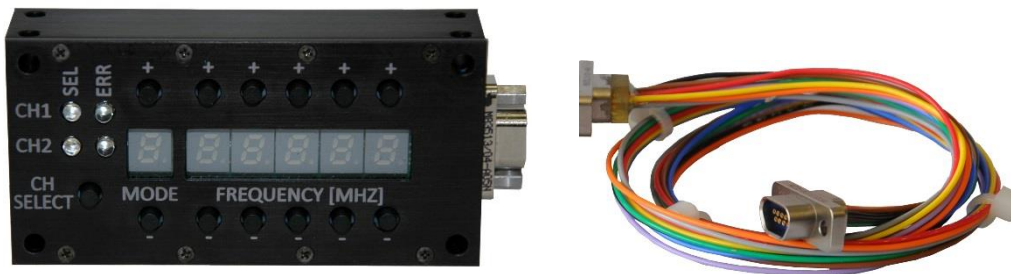

Figure 19: Digital Switch Box with 18” MDM-9 to MDM-9 Cable Harness

3 Installation Instructions

3.1 Mechanical

The standard 4.2 cubic inch TIMTER™ (04AB package) is designed to be mounted by four (4) 6-32 screws through the holes in the four corners, as depicted in Figure 21. Drawings for all TIMTER™ packages are located on the Quasonix web site.



Figure 20: 4.2 in3 TIMTER™

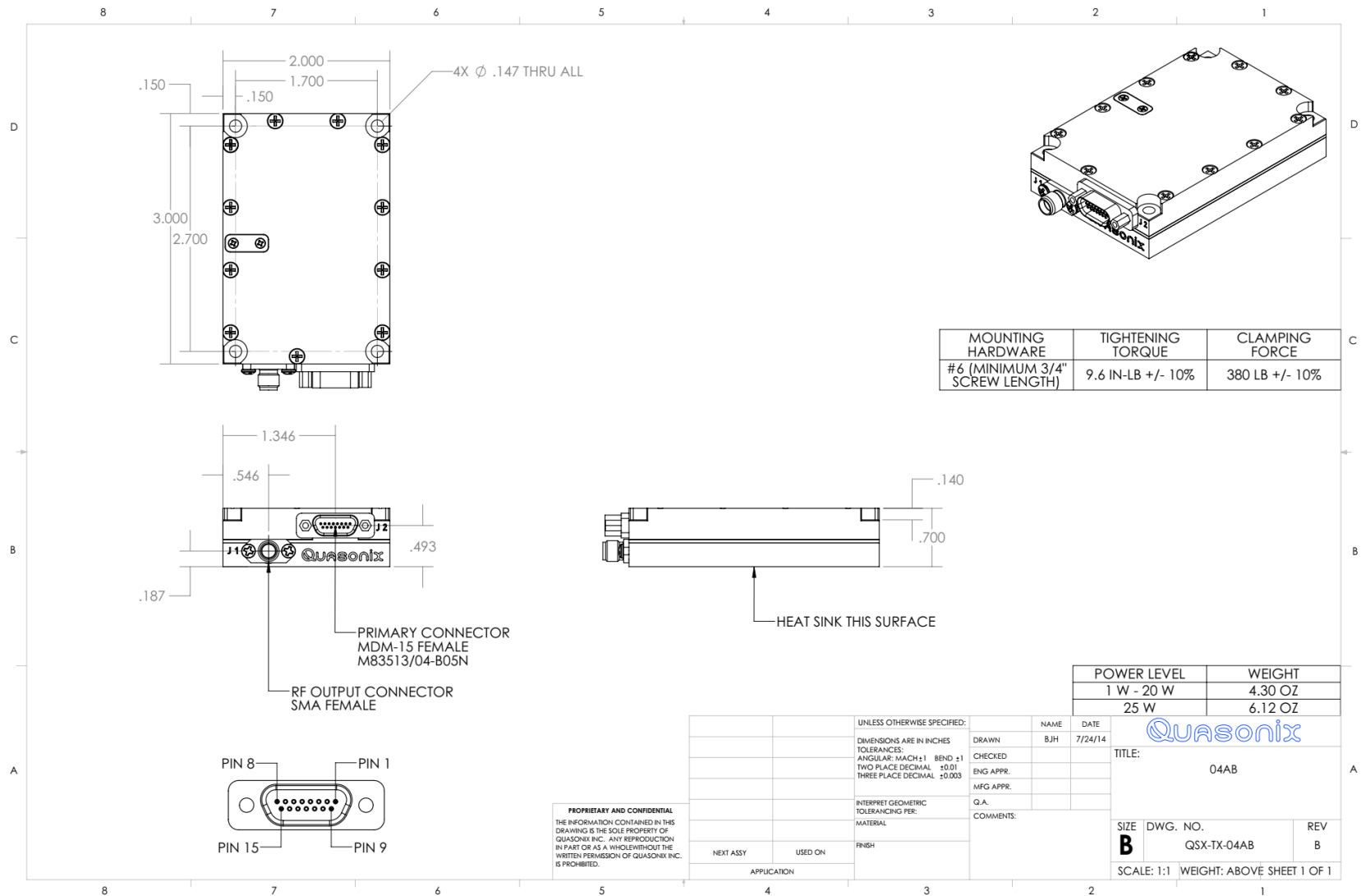

Figure 21: Outline Drawing, TIMTER™ 04AB Telemetry Transmitter

3.2 Thermal

It is important that the bottom surface (on the face opposite the product label) be securely attached to a baseplate capable of dissipating the power produced by the transmitter model in use. This mounting baseplate must be flat, smooth, and clean. Contact Quasonix for the heat sink power dissipation required for your transmitter model.

ATTENTION: Do not operate the transmitter without a proper heat sink. Failure to do so may lead to permanent damage to the unit and will void the warranty. Overheating can occur in a matter of seconds when a transmitter is not properly heat-sinked. In absolutely no case should any type of stickers or labels be applied to the bottom surface of the transmitter.

The heat sink required for a particular transmitter depends heavily on the installation. Factors such as altitude, air temperature, air flow, and mass of the mounting surface all have a substantial impact on the flow of heat away from the transmitter. Quasonix offers several types of integrated and add-on heat sinks (refer to section 2.1). Please contact Quasonix for heat sink recommendations for your particular TIMTER™ transmitter.

Regardless of the heat sink, Quasonix strongly suggests using a thermal pad, such as Q-Pad® II from Bergquist.

3.3 Electrical

The standard TIMTER™ has two external connectors, an MDM-15 type connector known as the primary, and an SMA female for the RF output connection. Certain transmitter options may require additional connectors.

The pin numbering and pin assignments for the transmitter connectors vary depending on the interface type, connector gender, and options ordered. A pinout *code* is assigned based on transmitter type and options. Section 1.2 describes the nomenclature/part number breakdown for transmitters.

Each pinout drawing contains the pinout code, a description of the connector (such as Female MDM-15), a photograph of the connector with the pins numbered appropriately, and a table showing the designated pin assignments, drawing name, and revision. Drawings may contain more than one connector (such as an MDM-15 and an MDM-9) depending on the application.

A sample pinout drawing is shown in Figure 22. This is only an example. Pinout drawings for all transmitters may be obtained from the Quasonix web site. Customers with security rules that prevent Internet access or file downloads may contact Quasonix Customer Service for assistance.

For pinout drawings, go to www.quasonix.com.

1. Select Resources from the menu bar.
2. Click on Product Drawings.
3. Select Product Category > Transmitters, Drawing Type > Pinouts.
4. Type the pinout code in the Search box and press Enter.
5. Click on the link or the pdf icon in the list.

When you click on the pinout link in the list, it should open the file in a new tab in the same browser window. Some applications may only allow downloads, but most browsers allow viewing, depending on

the local settings. Most browsers allow you to right click on the link and determine how to open it or print it, regardless of the default setting.

QUASONIX

TRANSMITTER PINOUT CODE 02

Connector: Female MDM-15

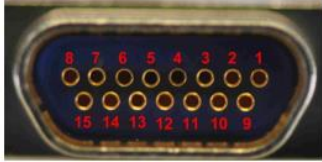

Pin	Function
1	DC Power In
2	DC Power Return
3	N/C
4	Differential Clock Positive
5	Differential Data Positive
6	Serial Control Ground
7	RF On/Off
8	Serial Control Input to Transmitter
9	DC Power In
10	DC Power Return
11	N/C
12	Differential Clock Negative
13	Differential Data Negative
14	Dual Power
15	Serial Control Input to Transmitter

DRAWING	qsx_pc02.docx		
REVISION	B		
DRAWN	MRE	DATE	08-17-2018
VERIFIED	DEF	DATE	08-17-2018
APPROVED	DEF	DATE	08-17-2018

No part of the document may be circulated, quoted, or reproduced for distribution without prior written approval from Quasonix, Inc.

Copyright Quasonix, Inc., All Rights Reserved.

Figure 22: Example Quasonix Pinout Drawing

The data is sampled on the falling edge of the clock, as shown in Figure 23.

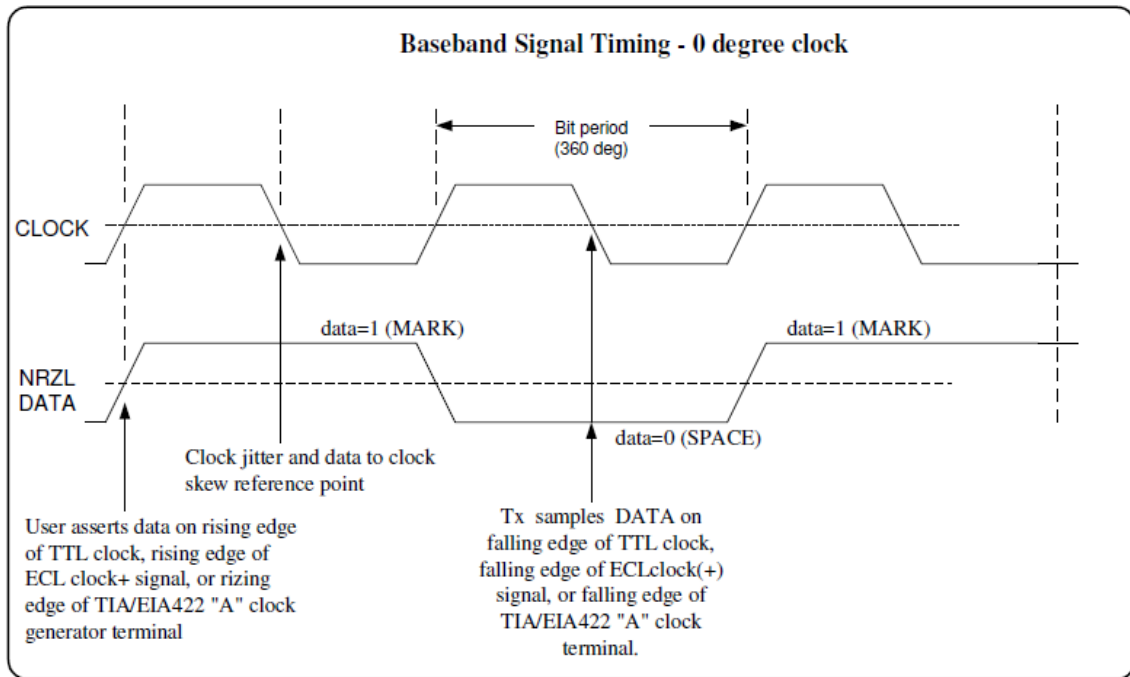

Figure 23: Baseband Signal Timing

4 Operating Instructions

4.1 Power-on Operation

Upon power up, the transmitter loads any stored parameters present in its nonvolatile memory. If parameters have not been stored previously, the transmitter initializes default parameters and then stores them in the first preset slot, 0. There are a total of 16 available software-based presets (0 through 15) for saving multiple parameters at once for future use.

PF / PM OPTION NOTE: Stored parameters are loaded based on the state of the startup configuration (SC) setting. The SC setting allows the user to choose the priority between the parameters stored in nonvolatile memory and the frequency and/or mode settings designated by pins on the external parallel control connector. For other variations, contact Quasonix.

4.1.1 Dual Power via Hardware Control

When the dual power option (DP) is specified, the transmitter uses the hardware pin to switch between the low power setting and the high power setting.

When the pin is left floating or pulled high (logical 1), the transmitter enters the high power mode. When the pin is grounded (logical 0), the transmitter enters the low power mode.

4.1.2 2nd Generation Switch Box Notes

If a Quasonix 2nd Generation Digital Switch Box is attached to the transmitter, and the digital switch box option is present (check the part/model number of the transmitter for DSWBX), all changes made to mode, frequency, or LDPC selections on the transmitter are also updated immediately on the Switch Box. This ensures the switch box settings always match those of the transmitter.

4.2 TIMTER™ Serial Control Protocol

When in Serial Control (Terminal) mode, the TIMTER™ is controlled via a simple three-wire serial interface (transmit, receive, and ground). The serial port configuration is as follows:

- 57600 baud rate (changeable depending on the configuration option)
- 8 bits
- No parity
- 1 stop bit
- No flow control

For setup and configuration via a standard Windows-based PC, you may use HyperTerminal. For a more flexible, full-featured control interface, we recommend Terminal, available for download from the Quasonix website (Documents tab > Accessories link) or directly at: http://www.quasonix.com/sites/default/files/terminal_ver20080315.zip.

If the terminal program is active when power is applied to the transmitter, the following welcome message displays, as shown in Figure 24. At this point, you can verify that your serial connection is active in both directions by issuing any standard command, such as “FR” to learn the frequency.

```

Quasonix Multi-Mode Digital Transmitter

Customer Part # = QSX-xxx-xx-xx...
Customer Name = Quasonix Customer
Contract # = 999999-9
TX Serial # = 1001
Hardware Rev: A
PA Rev: F
PA Serial #: 1001
PA Model #: XMTR-PAM-10-F-SCPA
IRIG 106-09
6025 Schumacher Park Drive
West Chester, OH 45069
(513) 942-1287
www.Quasonix.com
CAGE CODE: 3CJA9
FPGA HW Type: T4D
FPGA version: 001h 02ah
FPGA Build: 0x5B6C5E7C = Aug 9 2018 15:32:12
Firmware version: T4 V1.131 8/9/2018

Preset 0 read
SOQPSK>HVA table not valid for any band.
DL table not valid for any band.
Ready for Commands
SOQPSK>RF on/off pin changed from 0 to 1
SOQPSK>BB clock rate out of limits (clk = 0 kHz)
SOQPSK>
    
```

Figure 24: TIMTER™ Welcome Message

4.2.1 Command Set: Standard and Optional Commands

All standard and optional user commands in Table 13 consist of one or two alphabetic characters, followed by 0, 1, or 2 arguments. If the command is issued with arguments, there must be a space after the alphabetic characters. The commands are not case sensitive. A carriage return is required to initiate each command except for the single key commands described at the beginning of the table.

Most parameters set by these commands are stored in the unit’s nonvolatile flash memory (CS and DS are the exception). On power-up, ALL settings are restored from preset 0, which is the default power on configuration. If the parallel interface is active, then any applicable configuration settings are read from the parallel port and updated accordingly after the initial power on sequence is completed. Refer to the Startup Configuration command (SC) for exceptions.

All settings can be changed via the serial control port; however, parallel port settings will in general override the serial port settings. However, configurations can only be saved from the serial control port. Changes made by the user via either method are NOT saved unless the Save command (SV) is issued from the serial control port before powering down.

***SV Note:** Users may save internal clock and data in presets for bench debug use BUT on a power up or when a *hardware* preset is restored, **CS** and **DS** will be forced to **0** (external clock and data). This action prevents a transmitter from powering up or changing hardware presets and being set to internal clock and/or data. The **ONLY** way to restore CS and/or **DS** as **1** from a saved configuration is by executing the **RC** command.

Note: All user commands do not apply to all transmitters. Command availability varies depending on the options ordered and any project specific customization applied. Questions? Please call Quasonix for assistance.

Table 13: Standard and Optional User Commands

Mnemonic Command	Name	Description	Option (s) Required	Setting Saved?	Factory Default
[Frequency Step Down	Left square bracket key retunes the transmitter to the next lower frequency, as determined by the frequency step (FS) parameter Reply to the control window is the new frequency, in MHz No Enter key required	Standard	N/A	N/A
]	Frequency Step Up	Right square bracket key retunes the transmitter to the next higher frequency, as determined by the frequency step (FS) parameter Reply to the control window is the new frequency, in MHz No Enter key required	Standard	N/A	N/A
?	Help	Displays abbreviated list of available commands No Enter key required	Standard	N/A	N/A
<	Step Down Power	Incrementally steps down the output power level, from 31 down to 0 One step per key press No Enter key required	VP	N/A	N/A
>	Step Up Power	Incrementally steps up the output power level, from 0 up to 31 One step per key press No Enter key required	VP	N/A	N/A

Mnemonic Command	Name	Description	Option (s) Required	Setting Saved?	Factory Default
AC	Automatic Carrier Output	<p>Report or set automatic carrier output state</p> <p>With automatic carrier ON (AC 1), the unit will output an unmodulated, on-frequency carrier if there is no clock present. When automatic carrier is OFF (AC 0), the RF output will be muted in the absence of clock. Note that the AI, CF, and CS commands can create a clock, even when one is not externally applied.</p> <p>Examples:</p> <p>AC Report the automatic carrier state</p> <p>AC 0 Set automatic carrier OFF</p> <p>AC 1 Set automatic carrier ON</p> <p>Refer to section 4.2.1.1.1 for related AC command detail</p>	AC ACS	N Y	AC 1
AFMS	Analog FM	<p>Set analog FM mode</p> <p>Examples:</p> <p>AFMS 1.0 Set analog FM deviation in units of MHz per volt</p>	FM	Y	AFMS 0
AI	Aux Input Select	<p>Enable, disable, or show the current state of the auxiliary input</p> <p>With the auxiliary input active, the unit automatically switches to clock-free operation (CF 0).</p> <p>Examples:</p> <p>AI Report the current value of AI</p> <p>AI 1 Enable the aux input</p> <p>AI 0 Disable the aux input</p>	AI	Y	AI 0

Mnemonic Command	Name	Description	Option (s) Required	Setting Saved?	Factory Default
AIR	Analog Input Reference Select	<p>Select the reference level for the analog input</p> <p>Examples:</p> <p>AIR Report the current value of AIR</p> <p>AIR 1 Select 1.65V</p> <p>AIR 0 Select 0V</p>	AI (also software Rev J)	Y	AIR 0
BBCK	Check BB Clock	<p>Displays the current baseband clock value and source</p> <p>Example:</p> <p>BBCK</p> <p>BB clock rate = 0.999998 Mbps, src = Int Clk</p> <p>Refer to section 4.2.1.1.2 for related BBCK command detail</p>	Standard	N/A	N/A
BD	Display Bias Data	Display the most recent drain current, drain voltage, drive bias voltage, and final bias voltage	Depends on Tx version	N/A	N/A
BR	Bit Rate	<p>Used when the Clock Free (CF) option is specified and internal transmitter clock is in use</p> <p>Report or set the bit rate of the bit sync that is locking to the externally applied data</p> <p>Not to be confused with "IC", which sets the rate of the internally generated clock</p> <p>Bit rate must be below 35 Mbps to use automatic bit rate detection</p> <p>Examples:</p> <p>BR Report the bit rate</p> <p>BR 5 Set the bit rate to 5 Mbps</p> <p>BR A Set the bit rate automatically</p> <p>Refer to section 4.2.1.1.3 for related BR command detail</p>	CF	Y	BR 5

Mnemonic Command	Name	Description	Option (s) Required	Setting Saved?	Factory Default
BT	Baseband Interface Type	<p>Report or set baseband interface type</p> <p>Clock and data interfaces are set to either TTL or RS-422. Clock interface and data interface are always the same type.</p> <p>Examples:</p> <p>BT Report the baseband interface type</p> <p>BT T Set the baseband type to TTL single ended, bias 1.65V</p> <p>BT R Set the baseband type to RS-422 differential input</p> <p>Refer to section 4.2.1.1.4 for related BT command detail.</p> <p>Refer to Table 3 for Clock/Data Interface codes.</p>	Interface type D, M, or S	Y	BT R
CC	Convolutional Encoder	<p>Enables or disables the convolutional encoder</p> <p>Examples</p> <p>CC Report convolutional encoder state</p> <p>CC 0 Set the convolutional encoder to Disabled</p> <p>CC 1 Set the convolutional encoder to Enabled</p> <p>Refer to section 4.2.1.1.5 for additional CC command detail.</p>	CE	Y	CC 0
CF	Clock Free	<p>Report or set the clock free state</p> <p>Examples:</p> <p>CF Report the clock free state</p> <p>CF 0 Unit uses its internal bit sync (internally synthesized)</p> <p>CF 1 Unit uses its externally applied clock</p> <p>Also refer to Appendix C – Understanding Clock/Data, AC, and BR</p>	CF	Y	CF 1

Mnemonic Command	Name	Description	Option (s) Required	Setting Saved?	Factory Default
CG	Clock Generator Source Select	Report or set the clock generator output source Examples: CG Report the clock free state CG 0 Clock Gen output Off CG 1 Use Internal clock Refer to section 4.2.1.1.6 for additional CG command detail	CG	Y	CG 0
CP	Clock Polarity	Report or set clock polarity Examples: CP Display the current clock polarity CP 0 Set clock polarity to NOT inverted CP 1 Set clock polarity to inverted CP A Set clock polarity to auto; Automatically selects the most reliable clock edge	Standard	Y	CP A (firmware V2.xxx) CP 0 (firmware V1.xxx)
CR	Current Preset Read	Reports the currently selected software preset being used by the transmitter	Standard	N/A	CR 0

Mnemonic Command	Name	Description	Option (s) Required	Setting Saved?	Factory Default
CS	Clock Source	<p>Report or set the clock source Unit always reverts to CS 0 (external) at power-up</p> <p>Examples: CS Display the current clock source CS 0 Set clock source to external CS 1 Set clock source to internal</p> <p>When set to internal clock source, the data source must also be set to internal via the DS command in order to have synchronous, usable data.</p> <p>Also refer to Appendix C – Understanding Clock/Data, AC, and BR</p>	Standard	N	CS 0
DE	Differential Encoding	<p>Report or set differential encoding for the SOQPSK-TG or other PSK mode (Differential encoding typically disabled for other modes) If LDPC enabled, DE resets to 0. DE is not valid with MC enabled.</p> <p>Examples: DE Report the differential encoding setting DE 0 Set differential encoding OFF DE 1 Set differential encoding ON</p>	Standard	Y	DE 1
DIOR	Display I/O Register Addresses	<p>Displays I/O addresses of machine registers to make it easier to debug</p> <p>Example: DIOR Displays I/O addresses</p>	Standard	N/A	N/A

Mnemonic Command	Name	Description	Option (s) Required	Setting Saved?	Factory Default
DP	Data Polarity	Report or set data polarity Examples: DP Display the current data polarity DP 0 Set data polarity to NOT inverted (OFF) DP 1 Set data polarity to inverted (ON)	Standard	Y	DP 0
DS	Data Source	Report or set data source state Unit always reverts to DS 0 (external) at power-up Examples: DS Display current data source DS 0 Set data source to external DS 1 Set data source to internal (value of internal source is set by ID command)	Standard	N	DS 0
FP	Read Frequency Plug	Returns current value of mode and frequency from a switch box	PF, PM, or DSWBX	N/A	N/A
FPD	Frequency Plug Debugs	Displays the frequency plug (switch box) debugs with the current state for each channel	PF, PM, or DSWBX	N/A	N/A

Mnemonic Command	Name	Description	Option (s) Required	Setting Saved?	Factory Default
FR	Frequency	<p>If no argument is passed, it reports the frequency. If an argument is passed, it sets the frequency. The argument specifies the frequency in MHz. If the command is entered with a '?', then the allowed frequency ranges for this unit display.</p> <p>This command rounds the frequency to the nearest 0.5 MHz. If the rounded frequency is within one of the transmitter's allowed bands, the transmitter will tune that frequency and confirm the change for the user.</p> <p>If the frequency is outside of the allowed range for the unit, the transmitter will NOT retune but will report an error to the user.</p> <p>If the FO option is present, the resolution is 1 Hz (0.000001 MHz).</p> <p>Examples: FR Display the current frequency FR ? Display allowed frequency ranges FR 1436.5 Set frequency to 1436.5 MHz</p> <p>Refer to section 4.2.1.1.7 for related FR command detail</p>	Standard	Y	FR 1436.5

Mnemonic Command	Name	Description	Option (s) Required	Setting Saved?	Factory Default
FS	Frequency Step	<p>If no argument is passed, it reports the current frequency step. If an argument is passed, it sets the frequency step size, which is used by the left and right square bracket keys. The argument specifies the frequency step in MHz, with 0.5 MHz being the smallest available step.</p> <p>Valid range is 0.000000 MHz to 3000.000000 MHz</p> <p>Examples: FS Display the current frequency step FS 1 Frequency step = 1 MHz</p>	Standard	Y	FS 1
H or HE	Help	<p>Displays a list of available commands</p> <p>Commands require a carriage return at the end of the line and may also accept parameters</p> <p>Some commands may not be enabled depending on required options</p>	Standard	N/A	N/A
HP	High Power	<p>Report or set high power level</p> <p>Valid range is 0-31 in 1 dB steps or 0-31.5 in 0.5 dB steps, depending on the transmitter</p> <p>Examples: HP Report the present high power level HP 31 Set high power to 31 HP Max Set high power to the highest allowable value for the unit HP Min Set high power to the minimum allowable value for the unit</p>	DP	Y	HP 31
HX	eXtended Help	<p>Displays a full list of available commands</p>	Standard	N/A	N/A

Mnemonic Command	Name	Description	Option (s) Required	Setting Saved?	Factory Default
IC	Internal Clock Rate	<p>Report or set the internal clock rate</p> <p>This rate is used if the clock source is set to internal (CS 1). It should not be confused with “BR”, which sets the rate of the internal bit sync, which phase locks to the externally applied data, if Clock-free is enabled</p> <p>If no argument is passed, the unit reports the clock frequency. If a valid frequency is given, the internal clock frequency is set. The frequency is in MHz.</p> <p>Examples:</p> <p>IC Display current internal clock rate</p> <p>IC 4.95 Set internal clock rate to 4.95 MHz</p> <p>Valid range is 0.002 MHz – 46.0 MHz for most transmitters; some legacy transmitters 0.002 MHz – 28.0 MHz</p> <p>Observes same bit rate limits as HR/LR cmds (PCM/FM half)</p> <p>Refer to section 4.2.1.1.8 for additional IC command detail</p>	Standard	Y	IC 5

Mnemonic Command	Name	Description	Option (s) Required	Setting Saved?	Factory Default
ID	Internal Data Gen	<p>Report or set the internal data pattern</p> <p>This setting is used if the Data Source is set to internal (DS 1) and the Clock Source is set to internal (CS 1).</p> <p>When setting the data, the argument must be “PN6” (or “PN06”), “PN11”, “PN15”, or “PN23”, or a valid 4 digit hexadecimal value, or USER. If USER, two or more arguments may be included in format: ID USER pattern bitlen</p> <p>Pattern = A 32 bit hex pattern Bitlen = Number of bits (1-32) in the user pattern</p> <p>Examples: ID Report the internal data pattern ID PN15 Set internal data pattern to PN15 ID USER AA55 Set internal data pattern to 0xAA55</p> <p>In SOQPSK mode, ID USER 5555 or ID USER AAAA will result in an unmodulated carrier, at the nominal carrier frequency.</p>	Standard	Y	ID PN15
IMN	Internal Model Number	Display the internal model number for the transmitter	Standard	N/A	N/A

Mnemonic Command	Name	Description	Option (s) Required	Setting Saved?	Factory Default
IMP	Impedance Control	Allows user to change impedance of the clock and data inputs from 75 ohms to 10k ohms Examples: IMP 0 Set impedance to 10k input IMP 1 Set impedance to 75 ohms Refer to Table 3 for Clock/Data Interface codes.	Clock/Data interface code of A	Y	IMP 1
INF	Information Dump	INF does a large information dump providing the results of the following commands: SN, VE A, RFS, SS, ZZ, ZF, ZS, ZCP, ZC, ZR, ZY, SCP, SY, etc. This is typically to capture the state of the unit for debug.	Standard	N/A	N/A
IQR	I and Q Gain Ratio	Reports or sets the ratio of I to Q gain in dB Current mode must be SQPN or UQPSK Examples: IQR Display current I/Q ratio IQR 4 Set I to Q gain ratio to 4 dB Valid range is about -10 dB to +10 dB	SQPN or PSK	Y	
IQ	Independent I and Q Data	Enable or disable the use of independent I and Q data when the data source is set to internal; if enabled, the ID and QD commands set the two data patterns Examples: IQ Show the current state IQ 1 Enable independent I/Q data IQ 0 Disable the independent I/Q data	Standard	Y	

Mnemonic Command	Name	Description	Option (s) Required	Setting Saved?	Factory Default
IS	Input Source Selection	<p>Selects the clock and data source (and user pattern and clock rate, where applicable) using a single command</p> <p>IS PN15 4.5 Sets unit to internal clock/data with a PN15 pattern at 4.5 Mbps</p> <p>IS AT AUTO Sets unit to use the auxiliary TTL input in clock free mode with auto bit rate enabled</p> <p>IS EN 10 Sets unit to use the Ethernet interface for both clock and data and to set the desired bit rate to 10 Mbps</p> <p>Refer to section 4.2.1.1.9 or additional IS command detail</p>	Standard on all units version 2.409 or greater	N/A	N/A
LC	List Configurations	<p>Lists the stored configurations on the unit</p> <p>If a configuration number is supplied, then the saved parameters for that configuration are displayed.</p> <p>Examples:</p> <p>LC List all internal saved configurations</p> <p>LC 7 Show configuration 7 details</p>	Standard	N/A	N/A

Mnemonic Command	Name	Description	Option (s) Required	Setting Saved?	Factory Default
LD	LDPC Encoding Enable	<p>Enable, disable, or show the current state of the Forward Error Correction (FEC) / Low Density Parity Check (LDPC) encoder</p> <p>Examples:</p> <p>LD Show the current encoder state</p> <p>LD 1 Enable the LDPC encoder</p> <p>LD 0 Disable the LDPC encoder</p> <p>Automatically disables differential encoding; *PSK modes default to DE enabled</p> <p>Automatically re-enables DE for SOQPSK mode</p> <p>Refer to section 4.2.1.1.10 for additional LD command detail</p>	LD, LD6	Y	LD 0
LP	Low Power	<p>Report or set low power level</p> <p>Valid range is 0-31 in 1 dB steps or 0-31.5 in 0.5 dB steps, depending on the transmitter</p> <p>Examples:</p> <p>LP Report the present low power level</p> <p>LP 3 Set low power to 3</p> <p>LP Max Set low power to the highest allowable value for the unit</p> <p>LP Min Set low power to the minimum allowable value for the unit</p>	DP	Y	LP 0
MA	Modes Allowed	<p>Reports the modes enabled on the transmitter, as determined by the part number</p> <p>Example:</p> <p>MA Show available modes</p> <p>0 - PCMFM</p> <p>1 - SOQPSK</p> <p>2 - MHCPM</p>	Standard	N/A	N/A

Mnemonic Command	Name	Description	Option (s) Required	Setting Saved?	Factory Default
MC	NRZ-M Conversion	<p>Enables or disables the NRZ-L to NRZ-M conversion</p> <p>Examples:</p> <p>MC Show the current NRZ state</p> <p>MC 1 Enable the NRZ-L to NRZ-M conversion</p> <p>MC 0 Disable the NRZ-L to NRZ-M conversion</p>	CE	Y	MC 0
MO	Modulation	<p>Report or set modulation setting</p> <p>Mode 6, Carrier only, is present on every transmitter</p> <p>Examples: (depending on modes ordered)</p> <p>MO Report the modulation setting</p> <p>MO 0 Set modulation to PCM/FM</p> <p>MO 1 Set modulation to SOQPSK-TG</p> <p>MO 2 Set modulation to MULTIH CPM</p> <p>MO 3 Set modulation to BPSK</p> <p>MO 4 Set modulation to QPSK</p> <p>MO 6 Carrier only, no modulation</p> <p>MO 7 Set modulation to OQPSK</p> <p>MO 8 Set modulation to UQPSK</p> <p>MO 10 Set modulation to STDN</p> <p>MO 11 Set modulation to SQPN</p> <p>MO 12 Set modulation to Analog_FM</p>	<p>MO 12 requires FM option</p> <p>All other mode availability dependent on modes ordered</p>	Y	<p>MO 0 or the first one the customer has installed on the unit</p> <p>Example:</p> <p>MO 1 if no PCM/FM installed;</p> <p>MO 2 if only CPM installed</p>

Mnemonic Command	Name	Description	Option (s) Required	Setting Saved?	Factory Default
MS	Modulation Scaling	<p>Scales the deviation (modulation index) of the transmitted signal relative to the standard default deviation</p> <p>Example:</p> <p>For PCM/FM – if the standard modulation index is 0.7, setting MS to 2.0 scales a modulation index of 1.4</p> <p>Value range is .09 to 128.01</p>	MS	Y	MS 1
MV	Digital Board ADC Voltages	<p>Displays the digital board voltage ADC values; PA HVA voltage and current readings</p> <p>Example:</p> <p>MV Display current values</p> <pre> 5V Voltage : 5.586 V 28V Current : 0.789 A 28V input : 27.365 V HVA 2 Current: 0.008 A HVA 2 voltage: 13.958 V HVA 1 Current: 0.108 A HVA 1 voltage: 13.763 V 3.6V RF Voltage : 3.623 V 5.5VDC Voltage : 5.564 V 1.1V Voltage : 1.096 V 3.6V Dig Voltage: 3.626 V </pre>	Standard	N/A	N/A
OC	Overtemperature Control Enable	<p>Enables or disables overtemperature control</p> <p>OC 0 Disable Overtemperature Control</p> <p>OC 1 Enable Overtemperature Control</p> <p>Refer to section 4.2.1.1.11 for additional OC command detail.</p> <p>Note: Highly recommended NOT to disable this feature.</p>	Standard	Y	OC 1
OTA	Over-the-Air Rate	<p>Displays the current baseband and over-the-air bit rate. This information is also displayed on the RFS output.</p> <p>OTA Display over-the-air rate</p>	Standard	N/A	N/A

Mnemonic Command	Name	Description	Option (s) Required	Setting Saved?	Factory Default
PF	PSK Filter Select	<p>Sets or shows the current PSK filter selection This is valid if the PSK mode option is enabled and for any *PSK (legacy) modes</p> <p>Valid filter range is 0 to 255</p> <p>Examples: PF Show current PSK filter PF 42 Set PSK filter to 42</p>	All *PSK	Y	PF 255
PL	Power Level	<p>PL reports or sets the current power level setting for the dual power feature. If the user enters 1, the power level is set to current “high” power level (refer to HP command). If the user enters 0, then power is set to the current “low” power level (refer to LP command).</p> <p>Examples: PL Report the current power level state PL 0 Set the current power level to “low” PL 1 Set the current power level to “high”</p> <p>Disabled in Parallel Mode</p>	DP	Y	PL 0
PR or RE	Restore Defaults	<p>Restores factory default parameters for the unit</p> <p>Default is currently the lowest number modulation supported by the transmitter with the selected band and frequency limits</p> <p>Default power level is Full power</p>	Standard	N/A	N/A
QA	Query All	Displays common device settings in one compact display	Standard	N/A	N/A
QT or TE	Query Temperature	Report the temperature in degrees Celsius	Standard	N/A	N/A

Mnemonic Command	Name	Description	Option (s) Required	Setting Saved?	Factory Default
RA or RN	Randomizer	Report or set randomizer state Examples: RA Report the randomizer state RA 0 Set randomizer OFF RA 1 Set IRIG-106 randomizer ON RA 2 Set CCSDS randomizer ON	Standard RA 2 requires LD6 option and LDPC enabled	Y	RA 0
RC (or PP or RL)	Recall Configuration	Load a saved configuration into the active configuration if the configuration number entered is valid If the selected configuration has no valid data or the command is issued without a configuration number, the transmitter is initialized with the default data and saved. Example: RC Load configuration 0 (default setup) RC 3 Load configuration 3	Standard	N/A	N/A
RF	RF Output	Report or set RF output control state Note that there may be no RF output, even if the software control is set to ON. This can happen if there is no valid clock in use, or if the RF On/Off hardware pin is in the OFF state. Examples: RF Report the RF output state RF 0 Set RF output OFF RF 1 Set RF output ON Refer to section 4.2.1.1.12 for related RF command detail	Standard	Y	RF 1 (if option CP07, default is RF 0)

Mnemonic Command	Name	Description	Option (s) Required	Setting Saved?	Factory Default
RFS	RF Output State	<p>Displays information used to determine whether RF and modulation are actually On in the format</p> <p>Refer to section 4.2.1.1.13 for related RFS command detail</p>	Standard	N/A	N/A
RZ	RF On/Off Pin Polarity	<p>Set or show the polarity of the RF On/Off pin, which is pulled high internally to 3.3 VDC</p> <p>RZ 0 means the RF is ON when the RF On/Off pin is low</p> <p>RZ 1 means the RF is ON when the RF On/Off pin is high (floating)</p> <p>Examples:</p> <p>RZ Show the current RF On/Off polarity</p> <p>RZ 0 Set RF On/Off polarity to “pin low = on”</p> <p>RZ 1 Set RF On/Off polarity to “pin high = on”</p> <p>The default polarity on most Quasonix transmitters is <i>high</i>.</p> <p>The RF On/Off pin is a hard OFF control. No matter what state everything else is in, setting this switch input to the inactive state will turn RF Off.</p>	Standard	Y	RZ 1
SB	Cycles per Bit	<p>Report or set cycles per bit (The subcarrier frequency is cycles per bit times bit rate.)</p> <p>SB Report cycles per bit</p> <p>SB x Set cycles per bit</p>	STDN	Y	SB 0

Mnemonic Command	Name	Description	Option (s) Required	Setting Saved?	Factory Default
SC	Set Configuration Priority	Set or show current configuration priority setting. Valid settings are: 1 – Ignore stored setting; read frequency plug on power up 2 – Ignore frequency plug (always) Refer to section 4.2.1.1.14 for additional SC command detail	PM or PF	Y	SC 1 or 2 (refer to additional detail)
SD	Digital Pot	Report the value of the digital pot for HVA on the transmitter. Range is 0 to 255	Standard	N/A	255
SI	Spectral Inversion	Sets the modulation scaling to -1 * whatever the current scaling is in order to invert the spectrum This is in ADDITION to any changes in modulation scaling factor. That is, if you enter a negative MS and then turn SI on, you will have a NON_inverted spectrum. Examples: SI Report spectral inversion status SI 0 No inversion SI 1 Invert the spectrum	Standard	Y	SI 0
SN	Serial Number	Report the serial number for the unit	Standard	N/A	N/A
SS	Show Settings	Displays most of the common device settings in one compact display	Standard	N/A	N/A

Mnemonic Command	Name	Description	Option (s) Required	Setting Saved?	Factory Default
SV or SA (or PS or PW)	Save Configuration	<p>Saves the current transmitter configuration to a user-selected preset number, from 0 to 15 where 0 is the power-on default unless hardware presets are enabled</p> <p>The SV command also allows the user to assign an alias to the desired preset.</p> <p>Examples:</p> <p>SV 1 Save current configuration to preset 1</p> <p>SV 7 xyz Save current configuration to preset 7 and assign alias name "xyz"</p> <p>*Refer to SV Note below for exception</p>	Standard	N/A	N/A
SW	Frequency Sweep	<p>Sweeps the transmitter frequency between provided limits, with provided step size, at a fixed rate</p> <p>Examples:</p> <p>SW Displays current status</p> <p>SW ? Displays command help with status</p> <p>SW 1 Start the sweep</p> <p>SW 0 Stop the sweep</p> <p>SW 1 2200.5 2394.5 1.0 Sweep channel 1 between 2200.5 MHz and 2394.5 MHz in 1.0 MHz steps</p> <p>Refer to section 4.2.1.1.15 for additional SW command detail</p>	Standard	N/A	N/A

Mnemonic Command	Name	Description	Option (s) Required	Setting Saved?	Factory Default
SY	System Status	<p>Displays the system status of the transmitter</p> <p>The first argument specifies the period, in milliseconds, between status updates. Zero (0) disables continuous monitoring.</p> <p>The second argument specifies the number of status lines between header outputs.</p> <p>Examples:</p> <p>SY Displays current status report settings</p> <p>SY 0 Disables continuous reporting</p> <p>SY 5000 210 Sets status header output once every 210 status updates</p> <p>Refer to section 4.2.1.1.16 for additional SY command detail</p>	Standard	N/A	N/A

Mnemonic Command	Name	Description	Option (s) Required	Setting Saved?	Factory Default
SZ	Set Up System Status Reporting	<p>Selects values to be reported by the SY command; the argument is a string of characters that specifies, in order, the values included in the status report output</p> <p>Values may include:</p> <ul style="list-style-type: none"> A – Clock rate 0 B – Clock rate 1 C – Clock rate 2 D – Clock rate 3 F – Frequency 1 G – Frequency 2 I – CF rate1 J – CF rate2 M – Mode 1 N – Mode 2 T – Temperature 1 U – Temperature 2 <p>Examples:</p> <p>SZ ? SZ command Help with up to date list of status values</p> <p>SZ Show current values to be included in status report</p> <p>SZ MFGT Set status to show Mode 1, Frequency 1, Frequency 2, and Temperature 1</p>	Standard	Yes	
TD	Temperature Compensation Display	<p>Displays the HVA table and/or the DL table</p> <p>Examples:</p> <ul style="list-style-type: none"> TD Displays both tables TD ALL Displays both tables TD HVA Displays HVA table only TD DL Displays DL table only 	Standard	N/A	N/A

Mnemonic Command	Name	Description	Option (s) Required	Setting Saved?	Factory Default
TXBR	Transmitter Baud Rate	Temporarily changes system baud rate; for odd baud rates (non-standard) accuracy may vary Valid range is about 300 to 230,400 baud – Not saved when the transmitter is powered off Examples: TXBR Displays current system baud rate TXBR 200 Sets system baud rate to 200	Standard	N	N/A
VE (or RV)	Version (Revision Information)	Report the current Firmware (software) version information for the transmitter	Standard	N/A	N/A
VF	Variable FIFO Depth	Sets the FIFO depth for controlling latency time between bits in and bits out Valid range is 0 to 255 Example: VF 120 (120 = Variable Power)	VF	Y	VF 128
VP	Variable Power	Report or set variable power level Valid range is 0-31 in 1 dB steps or 0-31.5 in 0.5 dB steps, depending on the transmitter Examples: VP Report the variable power level VP 31 Set variable power to 31 VP 5 Set variable power to 5 VP Max Set variable power to the highest allowable value for the unit VP Min Set variable power to the minimum allowable value for the unit	VP	Y	VP Max
XDC	External Device Control	Report or set the state of the extra RS-422 output to use it to control an external device Refer to section 4.2.1.1.17 for additional XDC command detail.	XD	Y	XDC 0

Mnemonic Command	Name	Description	Option (s) Required	Setting Saved?	Factory Default
XDCH	External Device Channel	Report or set the state of the external device control output(s) Refer to section 4.2.1.1.18 for additional XDCH command detail	XD	Y	XDCH 3
XDF	External Device Frequency Switching Threshold	Report or set the frequency threshold at which the extra RS-422 output changes states Refer to section 4.2.1.1.19 for additional XDF command detail.	XD	Y	XDF 4400.0
XDP	External Device Polarity Invert	Report or set the polarity of the extra RS-422 output Refer to section 4.2.1.1.20 for additional XDP command detail.	XD	Y	XDP 0
ZA	Modulation Control Register	Reads and displays the modulation control register	Standard	N/A	N/A
ZC	Show Configuration Parameters	Display all configuration parameters If there is no argument, then the current params are displayed. If there is an argument (0-15), then that preset is displayed. If 'C' for current is entered, then the current params in memory are displayed. Examples: ZC Display all parameters ZC 2 Display preset 2 params ZC C Display current params in memory	Standard	N/A	N/A
ZF	Show Detailed Options	Displays the current hardware configuration and detailed state of the options on the transmitter	Standard	N/A	N/A
ZX	Show Preset Inputs	Displays the current preset inputs on the parallel connector Available presets depend on the number specified for the unit Values are PS2, PS4, PS8, or PS16 If the PS option is not specified, there is only one (1) hardware preset on the transmitter.	Standard	N/A	N/A

Mnemonic Command	Name	Description	Option (s) Required	Setting Saved?	Factory Default
ZY	Show Connector	Displays the transmitter's baseband connector pinout with proper gender, numbering, and signal labeling Valid only with standard 15-pin transmitters	Standard	N/A	N/A
ZZ	Show Options	Displays the current hardware configuration and options on the transmitter	Standard	N/A	N/A

All commands generate a response of one or more lines, which indicate successful completion of the command or an error.

After a command's response, the transmitter displays the mode name followed by the character ">" as a prompt, which may be interpreted as meaning the radio is ready to accept new characters. If the CP07 option is enabled, only the character ">" displays as a prompt.

***SV Note:** Users may save internal clock and data in presets for bench debug use BUT on a power up or when a *hardware* preset is restored, **CS** and **DS** will be forced to **0** (external clock and data). This action prevents a transmitter from powering up or changing hardware presets and being set to internal clock and/or data. The **ONLY** way to restore CS and/or **DS** as **1** from a saved configuration is by executing the **RC** command.

4.2.1.1 Additional Command Set Details

4.2.1.1.1 Automatic Carrier Output – AC

This command requires the AC or ACS option. These options allows the TIMTER to transmit a carrier wave when the clock input is absent, which would normally cause the RF output to be turned off.

If the AC *option* is present, the AC command is always enabled (1) even if a preset is saved with AC = 0.

If the ACS *option* is present, the saved setting of the AC command (preset 0) is used on power up instead of forcing AC = 1.

Also refer to Appendix C – Understanding Clock/Data, AC, and BR.

4.2.1.1.2 Baseband Clock – BBCK

The BBCK command displays the actual current baseband clock rate and source.

If Clock Free (CF command) is enabled, and the bit rate (BR command) is fixed at 5.5 Mbps:

```
1>BBCK
```

```
BB clock rate = 5.465334 Mbps, src = CF Man (Man indicates the bit rate was set manually)
```

If Clock Free is enabled, and the bit rate is set to Auto:

1>BBCK

BB clock rate = 7.699997 Mbps, src = CF Data (bit rate determined based on the input stream)

If Clock Free is disabled, and the bit rate is set to anything (doesn't matter since CF is disabled):

1>BBCK

BB clock rate = 7.699997 Mbps, src = Ext Clk (external clock)

For details about specific commands, refer to AC, BR, CF, or IC.

Also refer to Appendix C – Understanding Clock/Data, AC, and BR.

4.2.1.1.3 Clock Free Bit Rate – BR

The Clock Free Bit Rate is the bit rate used when the Clock Free (CF) option is specified and internal transmitter clock is in use. The BR command reports the bit rate. It also allows the user to set the hard bit rate on a clock free transmitter, or set the clock free bit rate to Automatic.

When set to Automatic, the internal transmitter logic determines the correct bit rate from the input data stream. For Automatic to work, the input data stream must be sufficiently randomized. The bit rate must be below 35 Mbps to use automatic bit rate detection.

Do not confuse the BR command with “IC”, which sets the rate of the internally generated clock.

Syntax: BR [A / rate]

where A is:

Automatic

where rate is:

A bit rate in Mbps that matches the input data rate

Examples:

BR Report the bit rate

BR 5 Set the clock free bit rate to 5 Mbps fixed

BR A Set the clock free bit rate automatically

BR A D Set the clock free bit rate mode to Auto and Disable warning

BR A E Set the clock free bit rate mode to Auto and Enable warning

Suppose this sequence of commands are issued:

1>BR A

CF Bitrate Mode set to Auto

1>BR

CF Bitrate Mode currently Auto

CF Bitrate currently 7.700 Mbps (CF Operation Enabled)

The rate shown is the rate determined by the bit sync looking at the data input.

Instead of using the automatic setting, the next example uses a manually set clock free data rate:

1>BR 6

CF Bitrate set to 6.000 Mbps fixed

1>BR

CF Bitrate currently 5.000 Mbps (CF Operation Enabled)

Since BR is set to a fixed rate, the displayed rate *is* the fixed rate. There could be garbage if the manually set fixed rate does not match the actual incoming data rate.

Next, assume the transmitter is NOT in clock free mode:

1>CF 1

CF Disable set to 1 (Normal)

1>BR A

CF Bitrate Mode set to Auto

1>BR

CF Bitrate Mode currently Auto

CF Bitrate currently 7.700 Mbps (CF Operation NOT Enabled)

Since the current setting is BR Auto, the rate shown is what would be used (as determined by the measured data input) if clock free were enabled.

If BR is set to a fixed value and clock free is disabled:

1>BR 6.1

CF Bitrate set to 6.100 Mbps fixed

1>BR

CF Bitrate currently 6.100 Mbps (CF Operation NOT Enabled)

This example set BR to a fixed rate, but since clock free is not enabled, it is not used.

Use the BBCK command to see the actual current clock rate being used.

Also refer to Appendix C – Understanding Clock/Data, AC, and BR.

For details about specific commands, refer to AC, BBCK, CF, or IC.

4.2.1.1.4 Baseband Interface Type - BT

BT sets the baseband interface type using the following options:

T = TTL single ended, bias 1.65V

R = RS-422 differential input

This command is only valid if the transmitter has the VR option which now includes interface types D, M, or S.

If the unit has the EG option, the BT command and the VR option are not allowed.

4.2.1.1.5 Convolutional Encoder – CC

Convolutional encoding is a form of legacy forward error correction. It requires more bandwidth than all but the lowest rate LDPC codes, and its error correcting performance is inferior to LDPC. If possible, LDPC is the preferred FEC. CC is mainly used with legacy PSK modes.

4.2.1.1.6 Clock Generator Source Select Command – CG

CG is only active if the unit has the -CG option. CG 0 is the default to match legacy units.

The CG command allows the user to pick one of the following for the clock generator output source:

0 Clock Gen output Off

1 Internal clock always

2 External clock always

3 Clock Free clock always

4 Active clock:

Internal clock if CS = 1

External clock if (CS = 0, CF = 1)

Clock Free clock if (CS = 0, CF = 0)

Syntax: CG 1 // Set CG output to external clock always

CG ? // Display the choices

4.2.1.1.7 Frequency – FR

When the FO option is installed, the desired offset may be typed with the frequency using the FR command. The frequency offset range +/- 1 MHz with a resolution of 1 Hz (0.000001 MHz).

The FO option offsets the synthesizer +X MHz and the FPGA -X MHz.

Examples:

Frequency Offset Using FR command:
 1>FR 2200.2
 Freq set to 2200.0 MHz
 Freq offset set to 0.200000 MHz
 Actual Output Freq set to 2200.200000 MHz

When programming a transmitter using a digital switch box, the switch box displays an error light if the user tries to program a frequency outside the range. Note that the transmitter allows up to 10 MHz outside of the standard defined frequency range, however this is not recommended, and behavior outside the range is not guaranteed. The switch box will send the appropriate value to the transmitter, but will still flash an error to indicate the value is outside the frequency range. If the frequency value passes 10 MHz, the transmitter displays a frequency not set message.

The example below shows a display from a Terminal session. The first line shows a message sent from the switch box (indicated by SWBX) with a frequency of 2200.5 MHz. The second line shows a frequency of 2190.5. The third line shows an attempt to change the frequency to 2190.0, which is 10.5 MHz outside the standard frequency range. In this case, the desired frequency was not set.

```
1>SWBX Chan 1, Freq set to 2200.5 MHz
1>SWBX Chan 1, Freq set to 2190.5 MHz
1>SWBX Chan 1, Freq Invalid (2190.0 MHz). Freq NOT set
```

4.2.1.1.8 Internal Clock Rate – IC

This rate is used if the clock source is set to internal (CS 1). It should not be confused with “BR”, which sets the rate of the internal bit sync, which phase locks to the externally applied data, if Clock-free is enabled.

If no argument is passed, the unit reports the clock frequency. If a valid frequency is given, the internal clock frequency is set. The frequency is in MHz.

The units used to describe the internal bit rate are sometimes used interchangeably, and may cause confusion. Megahertz (MHz) and Hertz (Hz) are cycles per second units, while Mbps (megabits per second) and bps (bits per second) are data rate units.

The internal clock is referred to as “clock,” so Hz or MHz is often used as the unit, since “clock” is a frequency.

If the clock is used to “clock” the bits at X MHz, then the throughput in bits is X Mbps. In other words, the internal clock also sets the baseband bitrate. That is why, in this case, units of Hz are equated with units of bps.

For example, 5,000,000 Hz or bps may be rewritten as 5.000 MHz or 5.000 Mbps.

4.2.1.1.9 Input Source Selection Command – IS

The IS command is used to select the clock and data source (and the user pattern and clock rate where applicable) for the transmitter with one command. This command can conceivably replace CS, DS, ID, IC, BR, BT, AIR, CF, and EN. *This command is standard on all units version 2.409 or greater.*

Syntax: IS [ds/?/pnxx/XXXX [cs/AUTO/rate]]

where **ds** is data source which can be:

- ET – external TTL data (if QSX-VxT or -VR enabled)
- ER – external RS-422 data (if QSX-VxR or -VR enabled)

- EL – external LVDS data (if QSX-VxL or -VR enabled)
- I – internal with currently selected data pattern
- PNxx - internal with specified PN sequence
- XXXX - internal with specified fixed 4 digit hex pattern
- AB – auxiliary input bipolar data (if -CF and -AI enabled)
- AT – auxiliary input TTL data (if -CF and -AI enabled)
- EN – Ethernet (if -EN enabled)

If ds = ET, then cs MAY be:

- Nothing (defaults to ET for an external TTL clock)
- ET for an external TTL clock
Actions: ds 0, cs 0, bt 1 (if needed), cf 1 (if needed)
- X for clock free with current BR (if -CF enabled)
Actions: ds 0, cs 0, (bt 1 if needed), cf 0
- AUTO for clock free with BR = auto
Actions: ds 0, cs 0, cf 0, br a (bt 1, ai 0, and en 0 if needed)
- XX.xxx for clock free with BR = XX.xxx
Actions: ds 0, cs 0, cf 0, br XX.xxx (bt 1, ai 0, and en 0 if needed)

If ds = ER or EL, then cs MAY be:

- Nothing (defaults to ER for an external RS-422 clock)
- ER for an external RS-422 clock
- EL for an external LVDS clock
Actions: ds 0, cs 0, bt 3 (if needed), cf 1 (if needed)
- X for clock free with current BR (if -CF enabled)
Actions: ds 0, cs 0, (bt 3 if needed), cf 0
- AUTO for clock free with BR = auto
Actions: ds 0, cs 0, cf 0, br a (bt 3, ai 0, and en 0 if needed)
- XX.xxx for clock free with BR = XX.xxx
Actions: ds 0, cs 0, cf 0, br XX.xxx (bt 3, ai 0, and en 0 if needed)

If ds = I, then cs MAY be:

- Nothing (defaults to internal clock at current IC rate) (displayed)
- I for an internal clock at current IC rate (displayed)
Actions: ds 1, cs 1, ic

- XX.xxx for internal clock with ic = XX.xxx
Actions: ds 1, cs 1, ic XX.xxx

If ds = PNxx, then cs MAY be:

- Nothing (defaults to internal clock at current IC rate) (displayed)
- I for an internal clock at current IC rate (displayed)
Actions: ds 1, cs 1, id pnxx, ic
- XX.xxx for internal clock with ic = XX.xxx
Actions: ds 1, cs 1, id pnxx, ic XX.xxx

If ds = XXXX, then cs MAY be:

- Nothing (defaults to internal clock at current IC rate) (displayed)
- I for an internal clock at current IC rate (displayed)
Actions: ds 1, cs 1, id XXXX, ic
- XX.xxx for internal clock with ic = XX.xxx
Actions: ds 1, cs 1, id XXXX, ic XX.xxx

If ds = AB, then cs MAY be:

- Nothing (defaults to clock free at current BR) (displayed)
Actions: ds 0, cs 0, ai 1, cf 0 AIR 0 br (en 0 if needed)
- X for clock free with current BR
Actions: ds 0, cs 0, ai 1, cf 0 AIR 0 br (en 0 if needed)
- AUTO for clock free with BR = auto
Actions: ds 0, cs 0, ai 1, cf 0 AIR 0 br a (en 0 if needed)
- XX.xxx for clock free with BR = XX.xxx
Actions: ds 0, cs 0, ai 1, cf 0 AIR 0 br XX.xxx (en 0 if needed)

If ds = AT, then cs MAY be:

- Nothing (defaults to clock free at current BR) (displayed)
Actions: ds 0, cs 0, ai 1, cf 0 AIR 1 br (en 0 if needed)
- X for clock free with current BR
Actions: ds 0, cs 0, ai 1, cf 0 AIR 1 br (en 0 if needed)
- AUTO for clock free with BR = auto
Actions: ds 0, cs 0, ai 1, cf 0 AIR 1 br a (en 0 if needed)

- XX.xxx for clock free with BR = XX.xxx
Actions: ds 0, cs 0, ai 1, cf 0 AIR 1 br XX.xxx (en 0 if needed)

If ds = EN, then cs MAY be:

- Nothing (defaults to Ethernet clock at current IC rate) (displayed)
Actions: ds 0, cs 0, en 1 (cf 1 if needed) (ai 0 if needed)
- EN for Ethernet clock at current IC rate) (displayed)
Actions: ds 0, cs 0, en 1 (cf 1 if needed) (ai 0 if needed)
- XX.xxx for Ethernet clock with ic = XX.xxx
Actions: ds 0, cs 0, en 1 ic XX.xxx (cf 1 if needed) (ai 0 if needed)

Notes:

- Numbers need only as many significant digits as necessary. For example, to specify 10 Mbps (for either BR or IC) you can enter 10, 10.0, 10.000, etc.
- Some command versions require the unit to have specific options and will not work without those options. For instance, you cannot specify EN for Ethernet unless the unit has the -EN option in the part number.
- While this command incorporates the functionality of nine (9) or more commands, those commands are still usable. For example, if the unit has the -VR option then the BT command can still be used by itself to switch between TTL and RS-422 inputs for clock and data.

Examples:

IS ET	Sets unit to 'normal' mode expecting external TTL clock and data to be applied to the unit inputs
IS PN15 4.5	Sets unit to internal clock/data with a PN15 pattern at 4.5 Mbps
IS AT AUTO	Sets unit to use the auxiliary TTL input in clock free mode with auto bit rate enabled
IS EN 10	Sets unit to use the Ethernet interface for both clock and data and to set the desired bit rate to 10 Mbps

4.2.1.1.10 Low Density Parity Check (LDPC) Command – LD

The LD command enables, disables, and shows the current state of the Forward Error Correction (FEC) / Low Density Parity Check (LDPC) encoder. There is an optional selection for the block and rate selection. This requires purchase of the LD6 option which enables LD and enables user code selection. LD6 also allows the randomizer command (RA or RN) to select CCSDS, if LDPC is enabled.

This is only valid in *PSK modes (not PCM/FM or MHCPM), and it automatically turns OFF differential encoding. When LDPC is disabled, the state of DE is determined by the mode (for example, all *PSK modes default to DE On.)

LDPC cannot be enabled if CC (convolutional encoding) is enabled.

LDPC cannot be set with MC enabled (NRZ-L only).

LDPC is disabled when a mode change occurs. This is true for all mode changes, *PSK or other modes. There are two exceptions: If preset 0 has LDPC enabled, it stays enabled after a power cycle. Any preset that has LDPC enabled, stays enabled after the preset is recalled (RC command).

If the transmitter includes the LD option (but not LD6), then LD 0 or LD 1 are used to disable or enable LDPC, as shown in the example immediately following. With the LD option, the block size and code rate are always 4096 2/3.

Examples:

- LD Show the current encoder state
- LD 1 Enable the LDPC encoder
- LD 0 Disable the LDPC encoder

If the transmitter includes the LD6 option, the user may select from the six implemented LDPC codes. This also allows user selection of the CCSDS randomizer using the RA or RN command. Adding LD6 automatically enables the existing LD option.

The IRIG standard calls out six variants of LDPC codes—all combinations of two different information block sizes (k=4096 bits and k=1024 bits) and three different code rates (r=1/2, r=2/3, and r=4/5).

LD6 Code	Block Size and Code Rate
0	k=4096, r=1/2
1	k=1024, r=1/2
2	k=4096, r=2/3
3	k=1024, r=2/3
4	k=4096, r=4/5
5	k=1024, r=4/5

With the LD6 option, use LD 0 or 1 to disable or enable LDPC, then use 0-5 to indicate the desired LDPC code. A space is required between the disable/enable code and the desired LDPC selection, as shown in the examples.

Examples:

- LD 0 Disable the LDPC encoder
- LD 1 2 Enable the LDPC encoder and set the block size and code rate to k=4096, r=2/3
- LD 1 5 Enable the LDPC encoder and set the block size and code rate to k=1024, r=4/5

4.2.1.1.11 Overtemperature Control – OC

OC is the overtemperature control enable command. The default value is enabled (set to 1).

The transmitter contains an internal thermal shutdown feature that gradually reduces transmit output power up to 6 dB below maximum as the internal temperature rises from approximately 100°C to 108°C. Transmitting automatically resumes when the temperature falls below these thresholds.

Note: This feature is not production tested and is intended as a last-ditch attempt to prevent damage. Exercising this feature can only be done by deliberately overheating the unit, which voids the warranty.

Contact Quasonix for the default overtemperature value specific to your transmitter. Refer to the technical guide “Quasonix Transmitter Overtemp Control Operation” on the Quasonix website for additional information.

4.2.1.1.12 RF Output – RF

RF enables or disables the RF power output from the transmitter. A 1 enables the output and a 0 disables it. If no parameter is entered, the current state displays.

Note that just turning the RF output on does not guarantee that RF is output. If there is not a valid clock (or in clock free, if there is no valid data (transitions) from which to derive a clock), then the RF output is Off (unless the unit has the AC option and the AC command is enabled, in which case a carrier on the current center frequency is output).

Also, if the unit has an RF On/Off pin that is pulled into the Off state (determined by the current setting of RZ), then there is no RF output.

Also refer to Appendix C – Understanding Clock/Data, AC, and BR.

4.2.1.1.13 RF Output State – RFS

The RFS command may display the following information, depending on available options, about the connected transmitter:

RFS

```

ModCtrlReg shdw = 00007003h          GPIO_In_reg      = 5C02FF37h
BB_ctl_reg      = 00000890h          CF_auto_ctl_reg = 00000000h
pa_ctl_shadow   = 00000006h
RF pin = 1      RZ 1 (high = RF on) PA Intfc NOT detected
DP opt 0       PL 1   bb interface: RS-422
CF opt 1       CF Normal
EN option 0    EN state 0
AC opt 1       ACS opt 0   AC Off         FO opt 1
AI opt 0       AI state disabled   SC 2
CE opt 1       RH opt 0     NRF opt 0     LD opt 1     LD6 opt 1
BB rate: 5.000 Mbps          OTA rate: 5.000 Mbps
MO 0   FR 1812.5 MHz FO 0.068 MHz SD 100
CS 0   DS 0   IC 5.000   ID pattern currently: PN23
BR 5.000 Mbps (Auto)
RF 1   CC 0   MC 0   MS 1.000   LP 0.0   HP 31.5
DE 0   RA 0   CP A   DP 0   SI 0   VP 31.5
bb_clk_okay: 1             clock free bitrate: N/A
Power Level = 31.5 dB     DL: 4400     i dac: 5075   q dac: 11362   iqr: -7.0 dB
Tmpcmp Enabled          DL chk Enabled          Synth locked
RF State: On           Desired RF: On           Last Dsrdr RF: On   LDPC Off code 2
BB rate: 5.000 Mbps     OTA rate: 5.000 Mbps     PA_RF_state = 0
TX Enable : 1           Bias Enable: 1           24V Run: 0
Synth_en = TRUE        Mod_en = TRUE           Vin_fault_detected = 0
T4 Atten 0.0 dB        PA Atten2 31.5 dB

```

4.2.1.1.14 Set Configuration Priority – SC

The SC command sets or shows the current configuration priority setting. When the transmitter is first powered on, it loads the default configuration from preset 0. Based on the setting of the SC parameter, the transmitter may look for a digital switch box sign-on and then attempt to read the frequency, mode, and LDPC settings from the switch box. This command requires the DSWBX (digital switch box) option to be valid.

Valid SC settings are:

- 1 – Read the switch box (frequency plug) on power up; thereafter, changes from either the switch box or Terminal interface are allowed.
- 2 – Ignore the switch box (frequency plug) ALWAYS; Only the Terminal interface works until the SC setting changes.

The default value is SC 1 if the DSWBX option is present on the transmitter.

The default value is SC 2 if the DSWBX option is NOT present on the transmitter.

The SC setting is only saved as part of a preset save. If SC is changed during regular operation and power is cycled on the transmitter, the SC setting reverts to the saved setting.

Switch Box Behavior Notes:

- a. If a switch box is present during power up of the transmitter, AND the SC command is set to 1, the switch box settings are read, and the mode, frequency, and LDPC values (if applicable), are set based on the switch box values.
- b. After a transmitter is powered up, if a switch box is disconnected from the transmitter and then reconnected (also referred to as hot plug-in), OR if the switch box was NOT detected on power up, but was detected at a later time (also a hot plug-in), then the transmitter settings for the mode, frequency, and LDPC are sent to the switch box to keep it in sync with the transmitter.
- c. After a transmitter is powered up, and a switch box is connected and detected, any change of mode, frequency, or LDPC on the switch box is detected by the transmitter and acted upon (if SC = 1)—a message *from* the switch box displays on the terminal or Handheld Programmer, such as “SWBX Chan 1, Mode set to SOQPSK” and the mode on transmitter is changed to SOQPSK—and any changed mode, frequency, or LDPC setting on the transmitter, is sent to the switch box to keep it in sync with the transmitter.

4.2.1.1.15 Frequency Sweep – SW

When a frequency sweep is started, it will run continuously until manually stopped, except for the following circumstances.

- If a mode change (from a terminal, Handheld Programmer, or switch box) or recall preset occurs, the sweep is automatically terminated.
- If the frequency on an attached switch box is changed while a sweep is running, the sweep terminates.
- If invalid sweep parameters are entered, or an error message occurs while a sweep is running, the sweep will terminate.

This is to ensure the integrity of the transmitter frequency during the parameter changes, and to keep the frequency displayed on a connected switch box in sync with the transmitter. For example, if the mode changes to SOQPSK while a sweep is running, the sweep is automatically terminated, then the new parameters are copied. Another example: if a sweep is running and the user attempts to change the sweep to “SW 1 1300 1400 1”, the transmitter recognizes an invalid frequency and disables the sweep.

It is possible to change sweep parameters while a sweep is running. Entering new sweep parameters such as “SW 1 1435.5 1442.5 1” seamlessly restarts the sweep with the new frequencies. An attached switch box is only updated with the original starting sweep frequency and the stop frequency. Changes during a sweep are not reported to the switch box.

The valid step size range is ≥ 1 kHz to ≤ 1000 MHz.

Examples:

SW ? Help (syntax)

SW Show the sweep status

SW 1 1435.5 1442.0 1 Set channel to enable (On), the start frequency is 1435.5 MHz, the stop frequency is 1442.0 MHz, sweep frequency step size is 1 MHz

4.2.1.1.16 System Status Command – SY

The status reporting period must be > 200 ms or zero (0) to disable. Items in the SY command are defined with the SZ command. The minimum update period is 200 ms (about 5 times per second).

For example:

SY 5000 (sets status period to 5 seconds)

SY 5000 100 (sets status header output once every 100 status updates)

The SY command is defined as follows.

Mode – Current mode number (such as 0 = PCM/FM)

CF Rate – Clock free estimated data rate. This rate is based on the external data input (TTL or RS-422) even if internal data is presently in use (CS = 1).

Freq – Tuned frequency

Tmp – Current temperature

Crate – Clock filter clock rate. This is the actual over the air bit rate, regardless of the selected data source, and including any increases due to encoding (LDPC or convolutional). IN clock free automatic mode, it may differ from CF Rate because it will track the bit sync rate (exact, if locked) rather than the clock free estimated rate (approximate).

This example display shows selected parameters for one channel.

CRateB0 (b/s)	CFRate1 (b/s)	Mode 1	Freq 1 (Hz)	Temp 1 (C)
7812666	0	0	1852000000	32.5

4.2.1.1.17 External Device Control Command – XDC

The XDC command controls the state and operation of the new TTL output pins on the switchbox interface connector.

Connector: Male MDM-9



Pin	Function
1	Ground
2	XDC Control Ground (only with option XD)
3	CH1 XDC Control Out (only with option XD)
4	No Connection
5	Transmitter Replies to Switch Box (only with option DSWBX)
6	3.3VDC + Output
7	No Connection
8	CH2 XDC Control Out (only with option XD)
9	Switch Box Commands to Transmitter

The user can manually set the output to 0, 1, or Automatic as follows.

In automatic mode, the actual XDC outputs are based on current frequency and the XDF and XDP settings.

These commands are specific to the XDC Control Output “channel” (pin 3/pin 8) selected by the XDCH command described in section 4.2.1.1.18.

XDC 0 means set the TTL control output to 0 unless XDP (polarity invert) is set, in which case it is set to 1.

XDC 1 means set the TTL control output to 1 unless XDP (polarity invert) is set, in which case it is set to 0.

XDC A means set the TTL control output based on the current frequency such that

if $FR \geq XDF$ then output is 1 if XDP is 0 (no invert)

or 0 if XDP is 1 (invert)

if $FR < XDF$ then output is 0 if XDP is 0 (no invert)

or 1 if XDP is 1 (invert)

Examples:

XDC ? Help

XDC Show the current external device control state

XDC 1 Set the TTL control output to 0 (assume polarity invert is set to 0)

XDC 0 Set the TTL control output to 1 (assume polarity invert is set to 0)

4.2.1.1.18 External Device Channel Command – XDCH

The XDCH command allows the user to select the current control output “channels” used by the XDC, XDF, and XDP commands. The “channels” refer to pin 3 and pin 8 on the MDM-9 connector, as shown in the pinout table in the XDC section (4.2.1.1.17). Pin 3 is the Channel 1 external device control output, and pin 8 is the Channel 2 external device control output.

The XDCH command sets the “channel” to 1, 2, or 3 for both. If “channel” 1 or 2 is selected, only that “channel” changes. If “channel” 3 is selected, both settings change together.

(This command is similar to the CH command used on a Dual Transmitter.)

4.2.1.1.19 External Device Frequency Switching Threshold Command – XDF

The XDF command sets the frequency threshold at which the TTL control output changes states. This command has no effect unless XDC is set to Auto.

XDF accepts and displays up to six decimal places, meaning the frequency (in MHz) can have precision down to 1 Hz. The trip point may be set to any frequency the transmitter supports. The valid range is 200.0 MHz to 5260.0 MHz.

Syntax: **XDF [?/freq]**

where freq is the frequency at which the TTL control output changes states if XDC is set to auto. Which state it changes to depends on the setting of XDP:

if $FR \geq XDF$ then output is 1 if XDP is 0 (no invert)
 or 0 if XDP is 1 (invert)

if $FR < XDF$ then output is 0 if XDP is 0 (no invert)
 or 1 if XDP is 1 (invert)

Examples:

XDF ? Help

XDF Show the current external device frequency switching threshold

XDF 4430.0 Set the current external device frequency switching threshold to 4430.0 MHz

4.2.1.1.20 External Device Polarity Invert Command – XDP

The XDP command sets the polarity of the TTL control output. In the definition, 0 means do NOT invert the polarity of the output, 1 means invert the polarity of the output.

It looks at the frequency and compares it to XDF to see whether XDC is set to auto, or just an XDC parameter, which will otherwise be 0 or 1. The output is determined from those.

Then, if XDP is 0, do nothing. If XDP is 1, invert the output.

Syntax: **XDP** [0/1]

where **XDP 0** (no invert) means set the TTL control output to

1 if XDC = 1 or if XDC = A and current FR \geq XDF

0 if XDC = 0 or if XDC = A and current FR $<$ XDF

XDP 1 (invert) means set the TTL control output to

0 if XDC = 1 or if XDC = A and current FR \geq XDF

1 if XDC = 0 or if XDC = A and current FR $<$ XDF

Examples:

XDP ? Help

XDP Show the current external device polarity invert state

5 RF Output Notes

There are three methods of muting the RF output. If you do not have RF output, check these conditions:

1. RF On / Off command – From the control terminal, type **RF** to query the current state of the RF On/Off variable. If it is 0, type **RF 1** to turn the output back on.
2. External clock removal – If the unit is configured to use the external clock (CS = 0), that clock's presence is detected. If it is not present AND the unit is not running in Clock Free mode, the RF output automatically shuts OFF (unless the AC or ACS option is present, in which case the RF output switches to just a carrier at the center frequency with no modulation on loss of clock). When the data clock comes back, the RF output automatically turns on. The lag from data clock state change to RF output change is about 0.1 seconds, but varies based on settings.

If the unit IS running in Clock Free mode, no clock is required, but the loss of data transitions is detected. This will cause the RF to shut OFF (or if AC or ACS option and AC is set to 1, change to a carrier on center frequency). When the data transitions begin again (or when an external clock is reapplied if NOT in Clock Free mode), the RF output turns on again.

3. RF On / Off pin – The RF On / Off pin is a hard OFF control for the RF output. The polarity of this pin is selectable using the RZ command. The RF On /Off pin (in the inactive state) forces RF OFF; the RF On /Off pin can only allow RF to turn on, but it cannot force it to turn on.

If RZ = 1 then a high level on the RF On / Off pin allows RF On.

If RZ = 0, then a low level (ground the RF On / Off pin) allows RF On.

The RZ command is described in section 4.2.1.

5.1 Troubleshooting the RF on a Quasonix Transmitter

The following is a quick, three-part test to verify that the RF output on the transmitter is working correctly. This procedure should work for most transmitters with no modifications, however the sheer number of extra options and variations means that some units will need some special instructions or may work slightly differently. Examples are auto-carrier (-AC option), clock free (-CF option) and recall-holdoff (-RH option). If the procedure below does not demonstrate the working RF output on the transmitter, please contact Quasonix technical support for further help in resolving the issue.

The three sections below demonstrate RF output functionality one step at a time: first a carrier, then a waveform based on internal clock and data, and finally the waveform using the user supplied external clock and data. Part one demonstrates a simple carrier output at the desired frequency. Part two demonstrates proper waveform modulation using internal clock and data generated by the transmitter itself. Part three switches to the user supplied external clock and data for normal operation. If the first two parts work correctly, then the only missing piece is the external clock and data, so resolving any final issues becomes easier.

Part 1: Checking for carrier power output on frequency

1. Turn on power to the transmitter.
2. Set the mode to 6 (carrier only) using command **MO 6**.
3. Set transmitter to the desired frequency using the **FR** command. For example, **FR 2200.5**.
 - To see the allowed frequencies on your unit, type **FR ?**.
4. Turn the soft RF control on with **RF 1**.

5. Use a Spectrum Analyzer to determine whether there is a stick at the desired frequency. If there is, go on to Part 2.
6. If there is no output, check the state of the RF On/Off pin.
 - If the pin appears to be in the correct state to enable the output, check the RF On/Off pin polarity using the **RZ** command.
 - If the polarity is incorrect, change it.
 - **RZ 1** sets the transmitter output to turn ON when the RF On/Off pin is high (3.3 VDC).
 - **RZ 0** sets the transmitter output to turn ON when the RF On/Off pin is low.
7. Is the output present now? If so, go on to Part 2 below. If not, call Quasonix for technical support.

Part 2: Verifying modulation output on frequency with internal data

1. Turn on the transmitter.
2. Set the mode to one of the available modes on your unit. For example, **MO 0** for PCM/FM, **MO 1** for SOQPSK, etc.
3. Set transmitter to the desired frequency using the **FR** command. For example, **FR 2200.5**.
 - To see the allowed frequencies on your unit, type **FR ?**.
4. Turn the soft RF control ON with **RF 1**.
5. Enable the internal clock source with **CS 1**.
6. Enable the internal data source with **DS 1**.
7. Set the internal clock rate to 5 Mbps with **IC 5**.
8. Set the internal data pattern to PN15 with **ID PN15**.
9. Use a spectrum analyzer to verify the desired waveform on the RF output at the desired frequency.
10. If the waveform is NOT present, check the state of the RF On/Off pin. Use the **RZ** command to check the current polarity of the RF On/Off pin.
 - **RZ 1** sets the transmitter output to turn ON when the RF On/Off pin is high (3.3 VDC).
 - **RZ 0** sets the transmitter output to turn ON when the RF On/Off pin is low.
11. Change either the RF On/Off pin or the polarity to turn the RF output ON.
12. Check for the RF output on the spectrum analyzer.
 - Is the output present now? If so, go on to Part 3.
 - If not, call Quasonix for technical support.

Part 3: Verifying modulation output on frequency with user data

1. Turn on the transmitter.
2. Set the mode to one of the available modes on your unit. For example, **MO 0** for PCM/FM, **MO 1** for SOQPSK, etc.
3. Set transmitter to the desired frequency using the **FR** command. For example, **FR 2200.5**.
 - To see the allowed frequencies on your unit, type **FR ?**.

4. Turn the soft RF control on using **RF 1**.
5. Disable the internal clock source with **CS 0**. This is the normal state on power up for most units.
6. Disable the internal data source with **DS 0**. This is the normal state on power up for most units.
7. Be sure that a clock source is connected to the correct pins of the transmitter input connector with the correct type (TTL or RS-422) of signal and in the case of RS-422, the correct polarity.
8. Be sure that the clock source is ON and that the clock rate is within the allowed range for the mode selected. Typically this is 100 kbps to 28 Mbps for Tier 1 and 2 waveforms and 50 kbps to 14 Mbps for Tier 0.
9. Be sure that a data source is connected to the correct pins, with the correct type (TTL or RS-422) and polarity as above.
10. Use a spectrum analyzer to verify the desired waveform on the RF output at the desired frequency.
11. If the waveform is NOT present, check the state of the RF On/Off pin. Use the **RZ** command to check the current polarity of the RF On/Off pin.
 - **RZ 1** sets the transmitter output to turn ON when the RF On/Off pin is high (3.3 VDC).
 - **RZ 0** sets the transmitter output to turn ON when the RF On/Off pin is low.
12. Change either the RF On/Off pin or the polarity to turn the RF output ON.

You may issue the RF command and observe the status which is returned. This status indicates whether the transmitter believes the RF output is actually ON or not.

The **SY** command may be issued to check the actual clock rate that the transmitter sees if no RF output is detected. One of the most common problems is a clock rate that is too high or too low (or missing) for the desired modulation.

Finally, if you have a full RF loop running with a BERT and are having trouble achieving a zero bit error rate or lock, try the loop using internal data with the standard PN15 bit pattern. Be sure the BERT pattern is set to match the selected data pattern (**ID** command) on the transmitter. Assuming the internal data syncs and produces a zero bit error rate, you can switch back to the external clock and data. In this case, you can also check (and change) the clock polarity (**CP**) the data polarity (**DP**), the randomizer (**RA**), and the differential encoder (**DE** – normally on for SOQPSK and off for other waveforms) to resolve the sync and bit error rate issues.

If you are still having difficulties at this point, then contact Quasonix technical support.

Quasonix Technical Support
(1-513-942-1287) or email (support@quasonix.com)

When calling technical support, it will speed things up if you have the following information handy:

- Model number (obtained with the **ZZ** command) ***Note that this is different from the customer part number.***
- Serial number (obtained with the **SN** command)
- Software Version (obtained with the **VE** command)

It is also helpful if you can call from a phone in your lab so our tech support people can actually walk you through setting, checking, and controlling your transmitter).

6 Performance Specifications

6.1 RF Output

The minimum RF output power is one of the following: 10 mW, 5 W, 10 W, 18 W, 20 W, or 25 W with the RF load VSWR < 2:1 at all phase angles from 0 to 360 degrees.

6.2 Electrical Current

The electrical current drain for TIMTER™ transmitters is provided in Table 14.

Table 14: DC Input Current at Standard Input Voltage

Band Type	Wattage	Maximum Current	Typical Current @ 28 VDC
L or S band	10 mWatt	0.3 amps	0.25 amps
L or S band	5 Watt	1.0 amps	0.85 amps
L or S band	10 Watt (2in ³ packages)	1.4 amps	1.1 amps
L or S band	10 Watt (>2in ³ packages)	1.8 amps	1.5 amps
L/S band	5 Watt	1.2 amps	1.0 amps
L/S band	10 Watt	2.2 amps	1.8 amps
L/S band	18 or 20 Watt	3.2 amps	2.8 amps
L band	18 or 20 Watt	3.2 amps	2.8 amps
S band	18 or 20 Watt	2.8 amps	2.5 amps
S band	25 Watt	3.2 amps	2.9 amps
C band	10 mWatt	0.3 amps	0.25 amps
C band	5 Watt	1.5 amps	1.3 amps
C band	10 Watt	2.4 amps	1.9 amps
C-band	18 Watt	3.4 amps	3.0 amps
L/C band and S/C band	10 mWatt	0.3 amps	0.25 amps
L/C band and S/C band	10 Watt	2.2 amps	2.0 amps
L/C band and S/C band	18 Watt	3.5 amps	3.2 amps
L/S/C band	10 mWatt	0.45 amps	0.40 amps
L/S/C band	10 Watt	2.5 amps	1.8 amps

6.3 Environmental Specifications

TIMTER™ transmitters meet the environmental requirements shown in Table 15.

Table 15: TIMTER™ Environmental Specifications

Environmental Specifications	Description
Operating temperature (10 mW, 1 W, 2 W, 5 W, 10 W models)	-40°C to +85°C
Operating temperature (18 W non-S/C band, 20 W, and 25 W models)	-40°C to +70°C
Operating temperature (18 W S/C band models)	-40°C to +60°C
Storage temperature (all models)	-55°C to +100°C
Operating humidity	0 to 95% (non-condensing)
Altitude	Up to 100,000 ft.

6.3.1 EMI Performance

Every Quasonix transmitter is designed to operate reliably and unobtrusively in the most challenging environments. This includes electromagnetic interference and compatibility (EMI/EMC) requirements. More specifically, all Quasonix transmitters in the TIMTER™ family (2 cubic inches and above) have been designed to comply with the following requirements of MIL-STD-461G (and MIL-STD-461E and -461F, when those now-obsolete standards have been applied):

Table 16: TIMTER™ EMI Compliance

Requirement	Description
CE101	Conducted Emissions, Audio Frequency Currents, Power Leads
CE102	Conducted Emissions, Radio Frequency Potentials, Power Leads
CE106	Conducted Emissions, Antenna Port
CS101	Conducted Susceptibility, Power Leads
CS114	Conducted Susceptibility, Bulk Cable Injection
CS115	Conducted Susceptibility, Bulk Cable Injection, Impulse Excitation
CS116	Conducted Susceptibility, Damped Sinusoidal Transients, Cables and Power Leads
RE101	Radiated Emissions, Magnetic Field
RE102	Radiated Emissions, Electric Field
RS101	Radiated Susceptibility, Magnetic Field
RS103	Radiated Susceptibility, Electric Field

Quasonix transmitters have been tested for compliance with these standards approximately annually since 2004. However, such testing is only performed as part of a qualification program, and the test results are the exclusive property of the customer who paid for them. If you need EMI testing on a particular part number, please contact sales@quasonix.com for a quote.

6.4 Carrier Frequency Tuning

The carrier frequency is selectable in 0.5 MHz steps, except for units with the FO (frequency offset) option. Frequencies supported by TIMTER™ transmitters are listed in Table 17.

Table 17: Carrier Frequencies (MHz)

Band ID Code	Band	Minimum Freq	Maximum Freq	Default Freq	Tuning Steps	Max Power
A	Lower S	2200.5 MHz	2300.5 MHz	2250.5 MHz	0.5 MHz	25 W
B	Mid C and Euro Mid C	5091.0 MHz	5250.0 MHz	5120.0 MHz	0.5 MHz	18 W
C	C “Low”	4400.0 MHz	4950.0 MHz	4620.0 MHz	0.5 MHz	18 W
D	C (with Mid C)	4400.0 MHz and 5091.0 MHz	4950.0 MHz and 5150.0 MHz	4620.0 MHz	0.5 MHz	18 W
E	(all) L, S, C	1435.5 MHz 1750.0 MHz 2200.5 MHz 2300.5 MHz 4400.0 MHz 5091.0 MHz 5150.0 MHz	1534.5 MHz 1855.0 MHz 2300.5 MHz 2394.5 MHz 4950.0 MHz 5150.0 MHz 5250.0 MHz	2370.5 MHz	0.5 MHz	10 W
F	S and C	2200.5 MHz and 4400.0 MHz	2394.5 MHz and 4950.0 MHz	2370.5 MHz	0.5 MHz	18 W
G	Euro Mid C	5150.0 MHz	5250.0 MHz	5150.0 MHz	0.5 MHz	18 W
H	L and C	1435.5 MHz and 4400.0 MHz	1534.5 MHz and 4950.0 MHz	1450.5 MHz	0.5 MHz	18 W
J	C, Mid C, and Euro Mid C	4400.0 MHz and 5091.0 MHz 5150.0 MHz	4950.0 MHz and 5150.0 MHz 5250.0 MHz	4620.0 MHz	0.5 MHz	18 W

Band ID Code	Band	Minimum Freq	Maximum Freq	Default Freq	Tuning Steps	Max Power
K	S and C, Mid C, and (with Euro Mid C)	2200.5 MHz 4400.0 MHz and 5091.0 MHz 5150.0 MHz	2394.5 MHz 4950.0 MHz and 5150.0 MHz 5250.0 MHz	2370.5 MHz	0.5 MHz	10 W
L	Lower L	1435.5 MHz	1534.5 MHz	1450.5 MHz	0.5 MHz	20 W
M	Lower L, Upper L, and S	1435.5 MHz 1750.0 MHz and 2200.5 MHz	1534.5 MHz 1855.0 MHz and 2394.5 MHz	1450.5 MHz	0.5 MHz	20 W
N	Upper S	2300.5 MHz	2394.5 MHz	2370.5 MHz	0.5 MHz	25 W
Q	L, S, and C	1435.5 MHz 1750.0 MHz 2200.5 MHz 4400.0 MHz 5091.0 MHz	1534.5 MHz 1855.0 MHz 2394.5 MHz 4950.0 MHz 5150.0 MHz	1450.5 MHz	0.5 MHz	10 W
S	S	2200.5 MHz	2394.5 MHz	2370.5 MHz	0.5 MHz	20 W
T	Lower L and C	1435.5 MHz 4400.0 MHz 5091.0 MHz 5091.0 MHz	1534.5 MHz 4950.0 MHz 5150.0 MHz 5250.0 MHz	1450.5 MHz	0.5 MHz	18 W
V	S and C (with Mid C)	2200.5 MHz 4400.0 MHz and 5091.0 MHz	2394.5 MHz 4950.0 MHz and 5150.0 MHz	2370.5 MHz	0.5 MHz	18 W
W	S, Mid C, and (with Euro Mid C)	2200.5 MHz 5091.0 MHz 5150.0 MHz	2394.5 MHz 5150.0 MHz 5250.0 MHz	2370.5 MHz	0.5 MHz	18 W
X	Mid C band	5091.0 MHz	5150.0 MHz	5120.0 MHz	0.5 MHz	18 W
Y	L and C	1435.5 MHz 1750.0 MHz and 4400.0 MHz 5091.0 MHz	1534.5 MHz 1855.0 MHz and 4950.0 MHz 5150.0 MHz	1450.5 MHz	0.5 MHz	18 W

Band ID Code	Band	Minimum Freq	Maximum Freq	Default Freq	Tuning Steps	Max Power
Z	Lower L, Mid C, and Euro Mid C	1435.5 MHz 5091.0 MHz and 5150.0 MHz	1534.5 MHz 5150.0 MHz and 5250.0 MHz	1450.5 MHz	0.5 MHz	18 W

6.5 Carrier Frequency Error

The frequency error is ± 6 ppm for all causes, including aging over five (5) years.

6.6 Bit Error Rate

The transmitter meets the following BER limits when tested with the Quasonix' multi-mode, multi-symbol trellis demodulator.

Table 18: Transmitter BER Specifications with Quasonix Demodulator

BER	Maximum Eb/N0 (dB)		
	PCM/FM, Tier 0	SOQPSK-TG, Tier I	MULTI-h CPM, Tier II
10-3	7.0	9.0	11.8
10-4	8.5	11.0	13.3
10-5	9.5	12.5	14.3
10-6	10.5	14.0	15.3

6.7 Modulated RF Power Spectrum

The transmitter’s modulated spectrum complies with the IRIG-106 PSD mask:

$$M \text{ (dBc)} = \text{Max} (\{K - 100 \log |f - f_c| + 90 \log (R)\}, \{-55 + 10 \log (P)\}), |f - f_c| \geq R/m \text{ where}$$

- M = power relative to unmodulated carrier (i.e., units of dBc) at frequency f (MHz)
- f = frequency in MHz
- f_c = the carrier frequency in MHz
- R = the bit rate in Mb/s
- P = the rated power output of the UUT, in Watts

and the values of K and m are as tabulated in Table 19.

Table 19: K and m Values per Waveform

	K	m
PCM/FM, Tier 0	-28	2
SOQPSK TG, Tier I	-61	4
MULTI-h CPM, Tier II	-73	4

As noted in the equation above, the mask has a floor at $-(55 + 10 \log(P))$ dBc, and the mask imposes no limit on the spectrum for frequency offsets less than R/m. Representative examples of the transmitted spectrum, with the appropriate mask, are shown in Figure 25, Figure 26, and Figure 27.

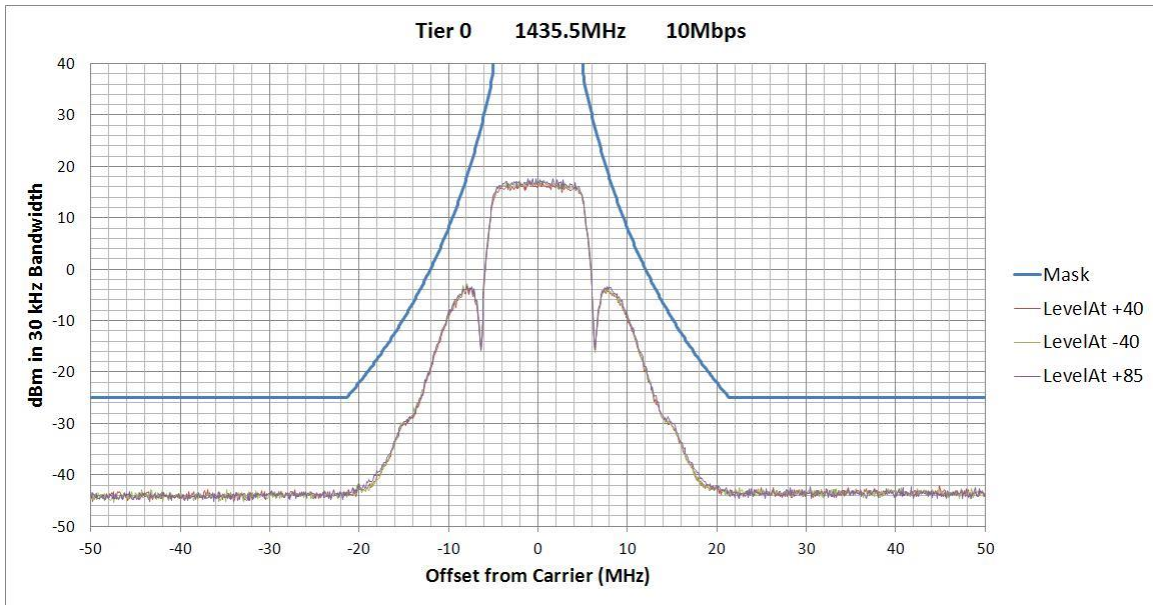

Figure 25: PCM/FM (Tier 0) Power Spectral Density with Mask

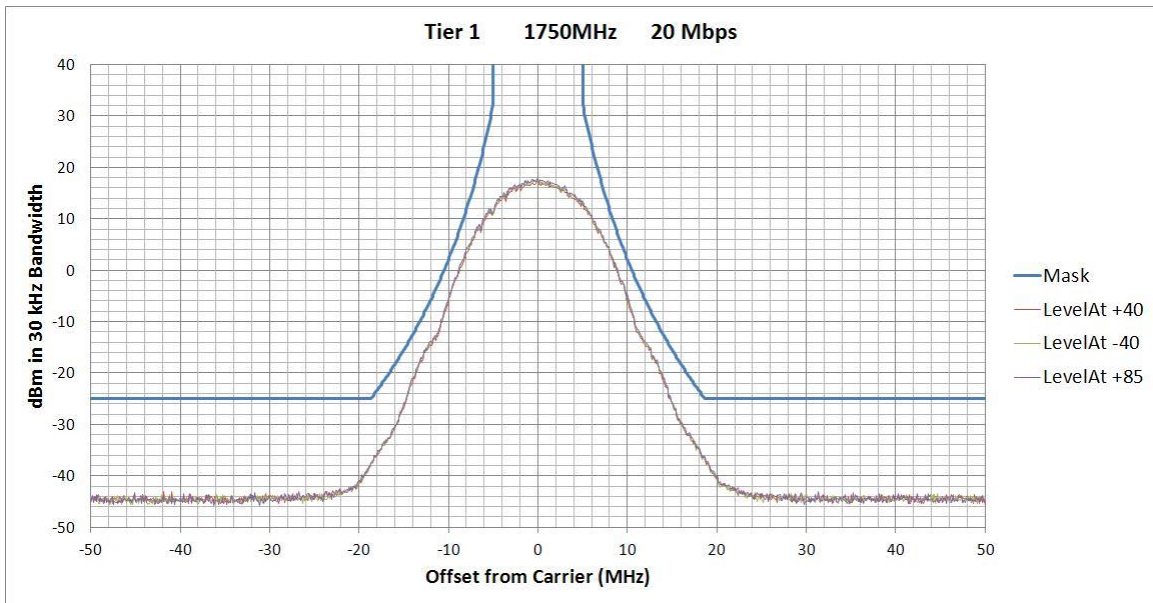

Figure 26: SOQPSK-TG (Tier I) Power Spectral Density with Mask

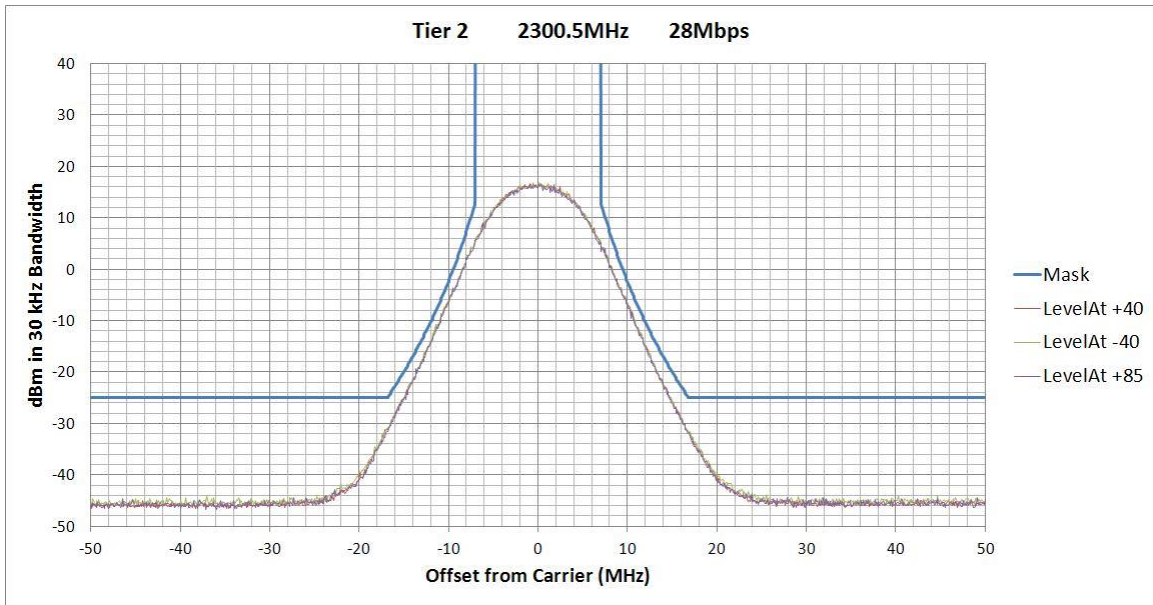

Figure 27: MULTI-h CPM (Tier II) Power Spectral Density with Mask

6.8 Phase Noise Power Spectrum

TIMTER™ phase noise limits are shown in Figure 28.

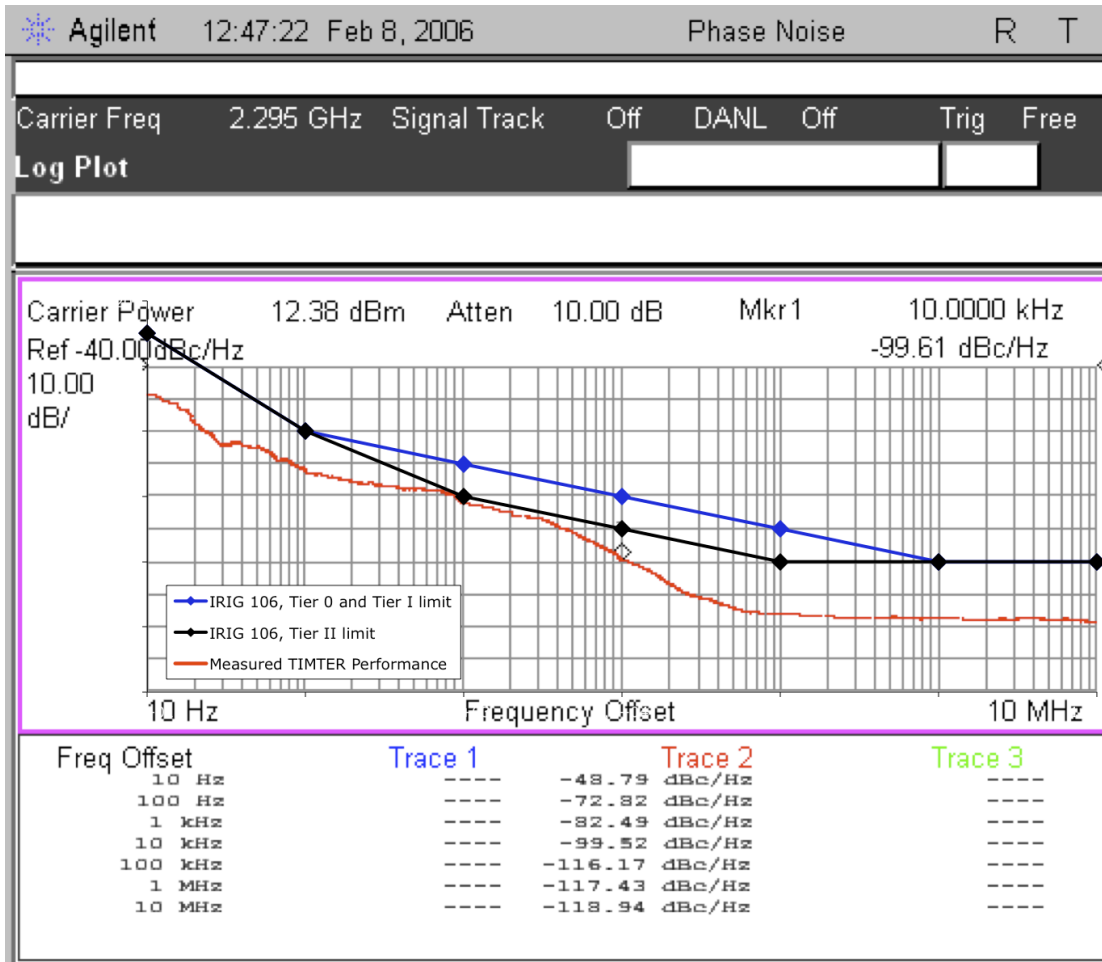

Figure 28: Phase Noise Limit Curve

6.9 Baseplate Temperature

TIMTER™ is designed for efficient heat transfer between internal heat producing sources and the baseplate. The 10 mW, 20 mW, 5 W, and 10 W TIMTER™ versions are rated for operation with baseplate temperatures ranging from -40°C to +85 °C, while the 20W version is rated from -40°C to +70 °C.

6.10 Vibration and Shock

The transmitter is designed and tested to operate normally when subjected to random vibration and shock. The shock and vibrate test setup employed by Quasonix is shown in the following figures.



Figure 29: Vibration / Shock Testing System



Figure 30: TIMTER™ Mounted for Z-axis Testing

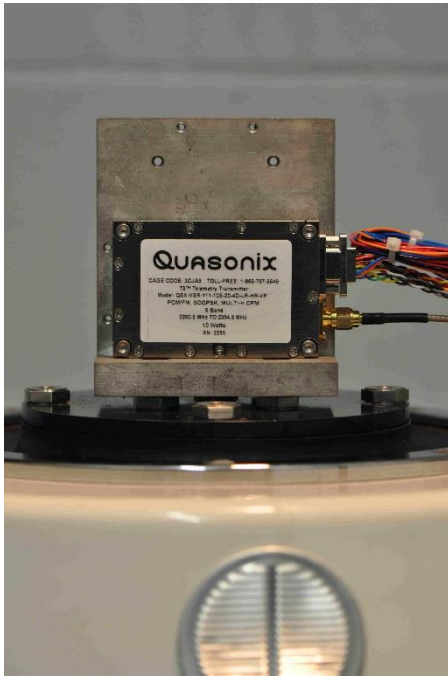

Figure 31: TIMTER™ Mounted for X-axis Testing

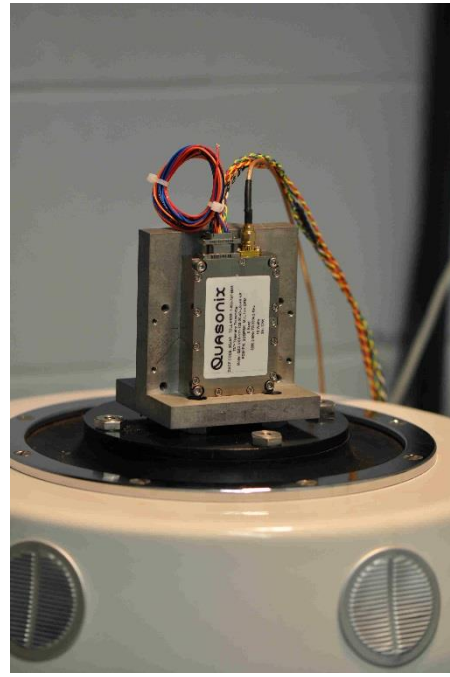

Figure 32: TIMTER™ Mounted for Y-axis Testing

6.10.1 Vibration Testing

Each transmitter is subjected to the random vibration spectrum depicted in Figure 33 and Table 20 prior to shipment.

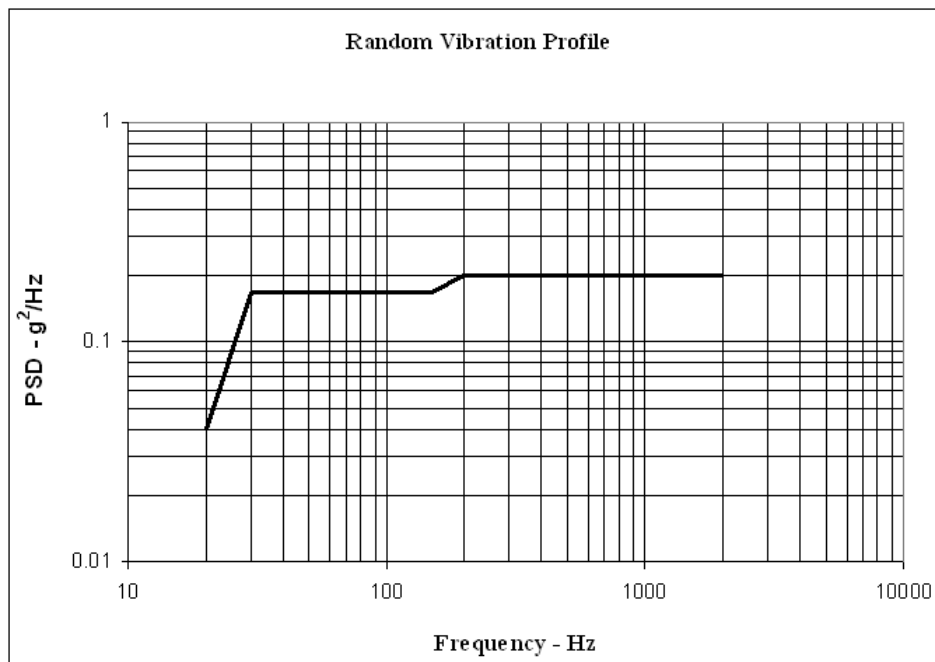

Figure 33: TIMTER™ Vibration Profile

Table 20: Random Vibration Spectrum

Breakpoints	
Frequency (Hz)	PSD (g ² /Hz)
20	0.04
30	0.17
150	0.17
200	0.2
2000	0.2
G (RMS) = 19.6	

During flight-qualification testing, the unit under test (UUT) was shaken for 30 minutes in each axis. The results are shown in Figure 34, Figure 35, and Figure 36.

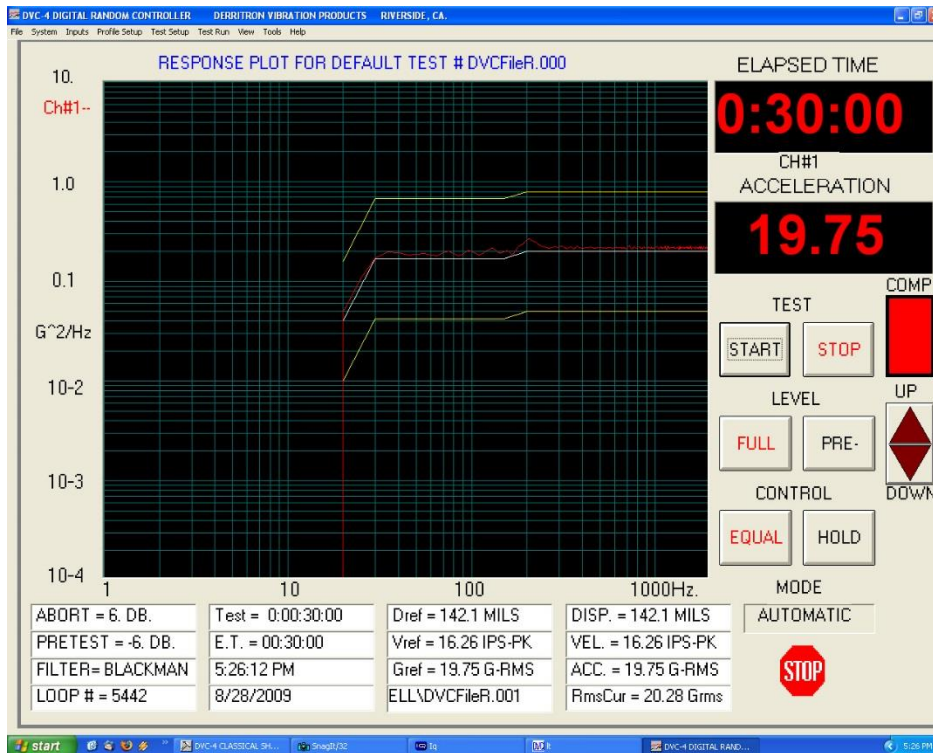

Figure 34: Z-axis Vibration Spectrum

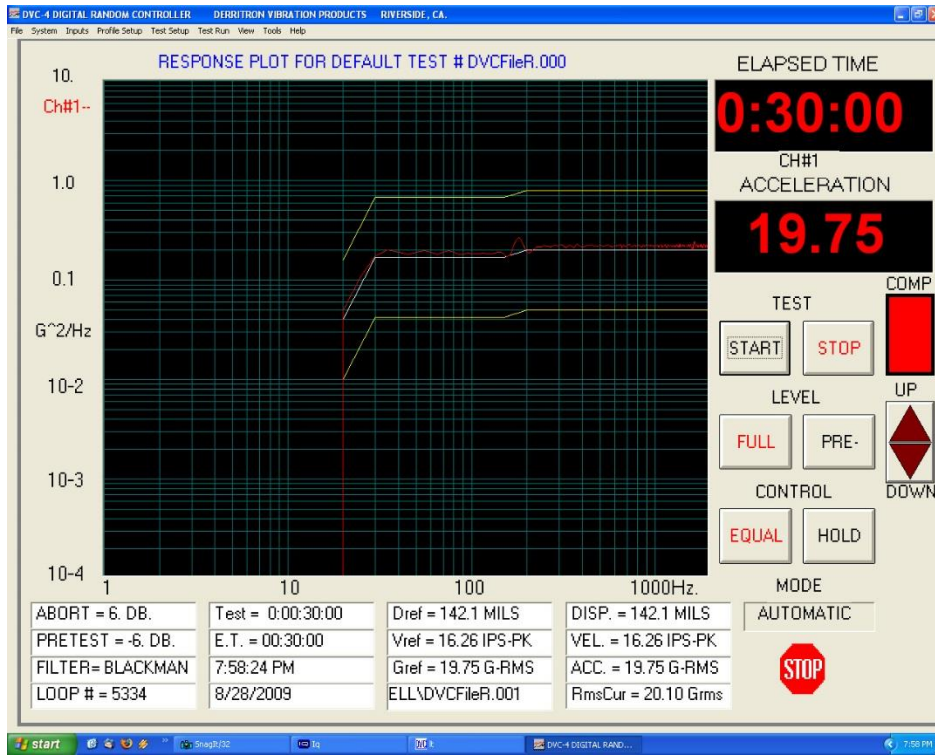

Figure 35: Y-axis Vibration Spectrum

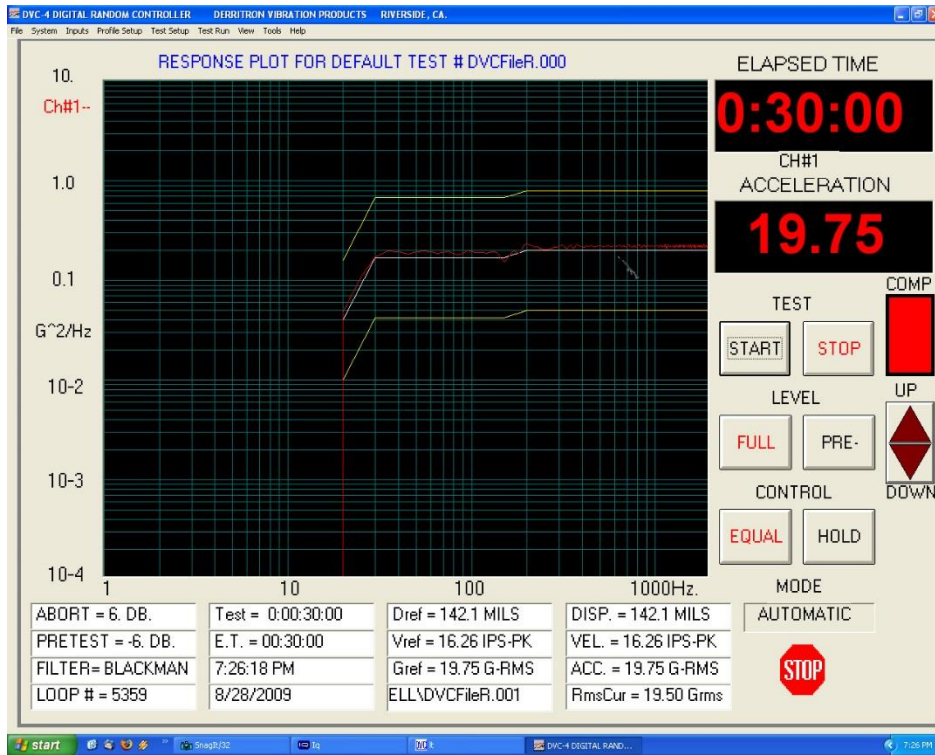

Figure 36: X-axis Vibration Spectrum

6.10.2 Shock Testing

In addition to vibration testing, the UUT was subjected to shock pulses, as follows:

- Type: Half-sine
- Level: 60 g
- Duration: 5 milliseconds

Application: Three (3) shocks in each direction of the three (3) orthogonal axes both positive and negative, for 18 shocks total

The plots of the positive and negative pulses in each of the three axes are shown in the following figures:

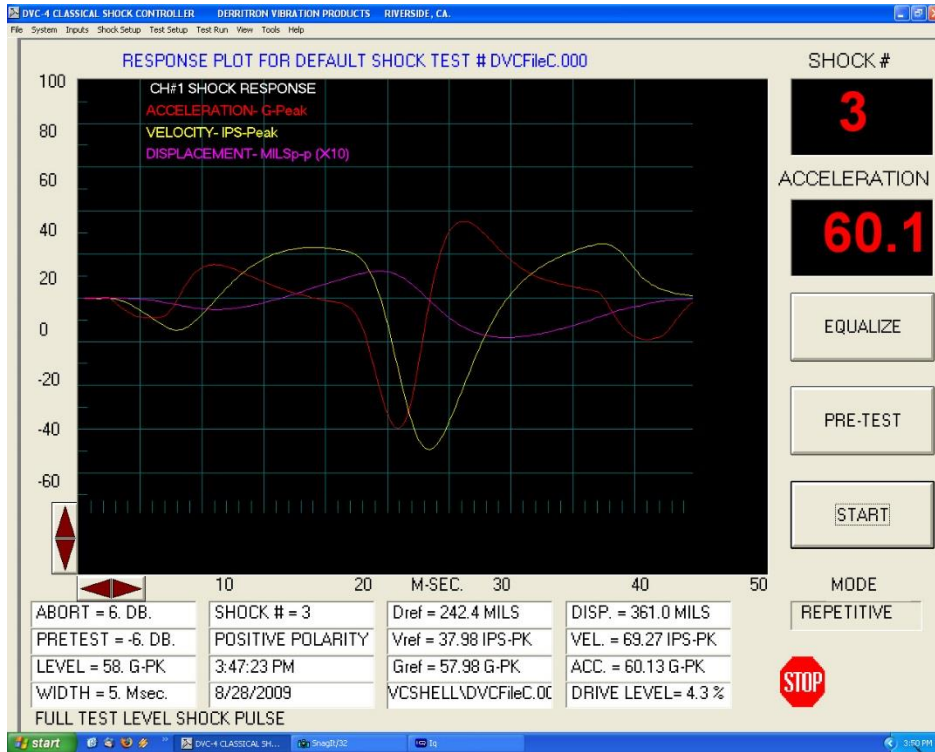

Figure 37: Shock Pulse, Z-axis Positive

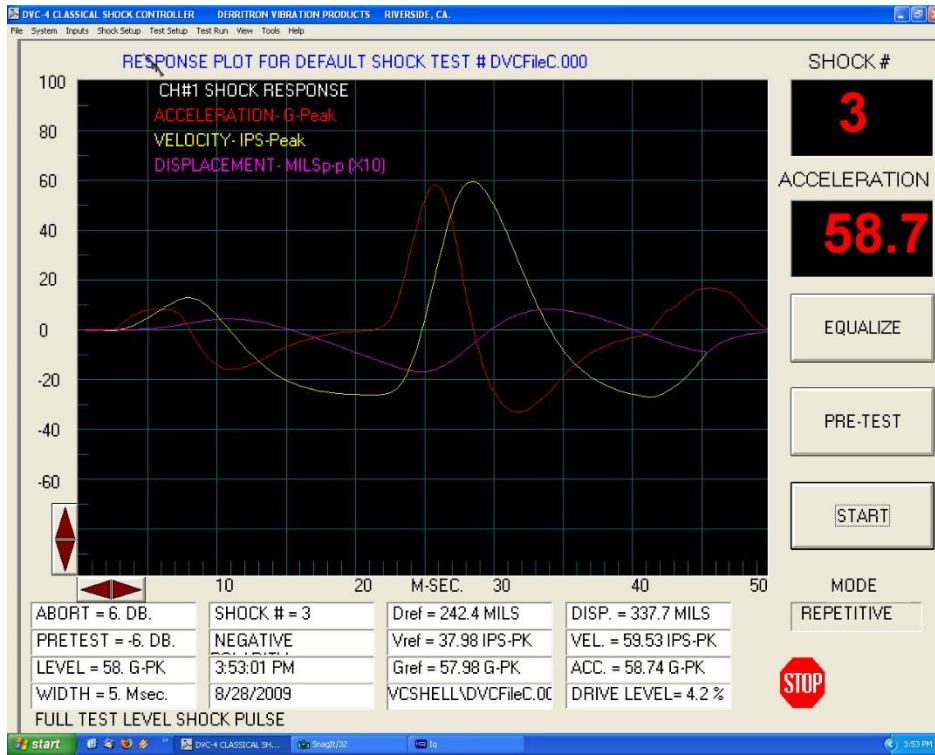

Figure 38: Shock Pulse, Z-axis Negative

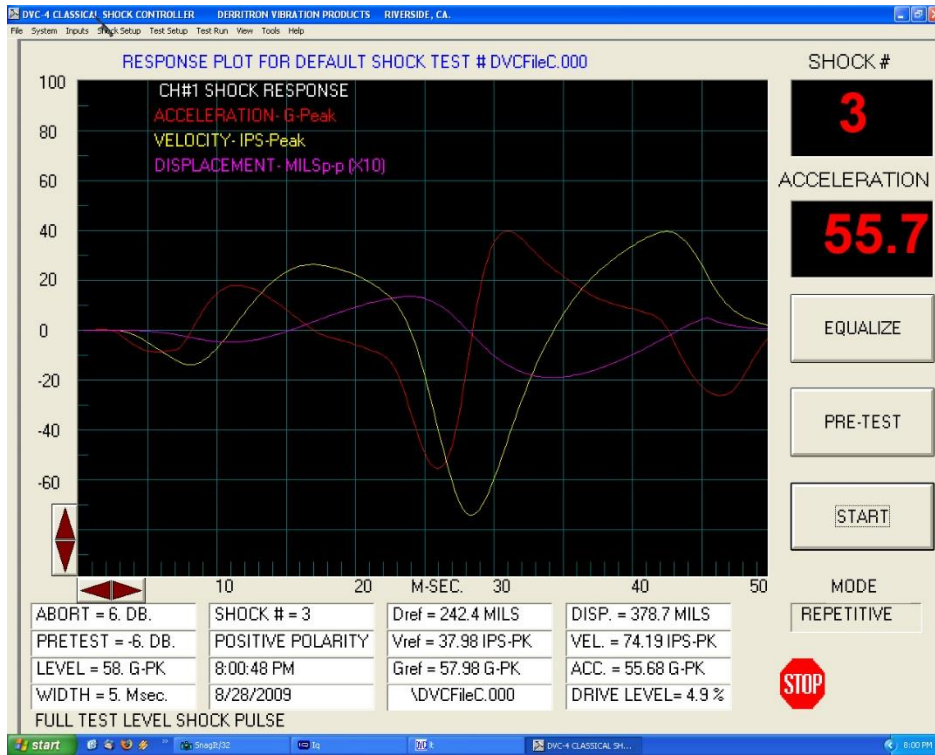

Figure 39: Shock Pulse, Y-axis Positive

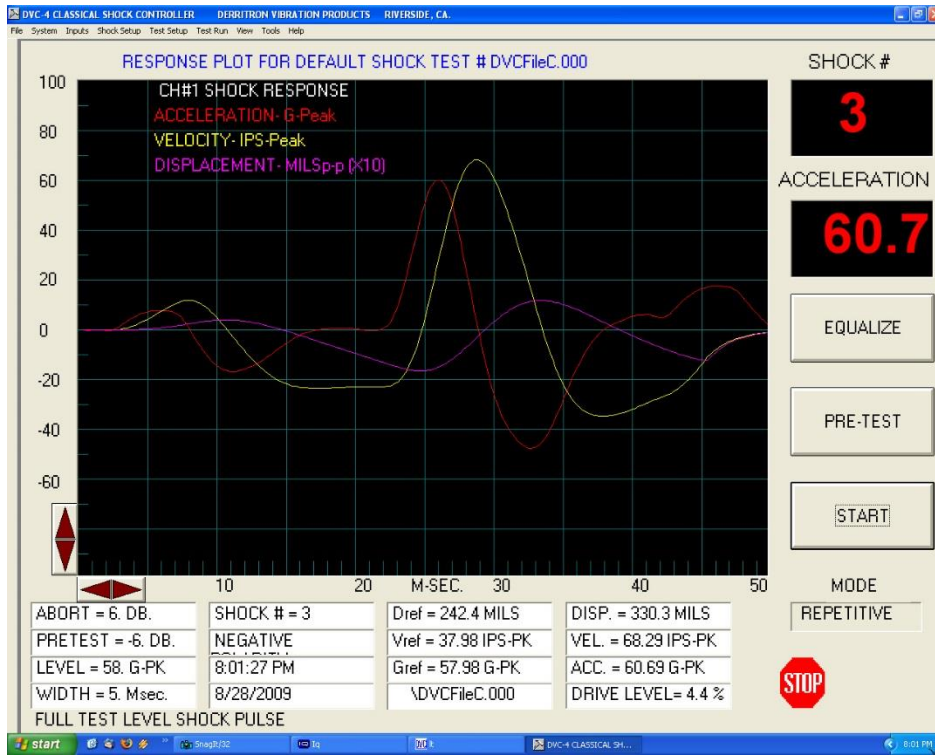

Figure 40: Shock Pulse, Y-axis Negative



Figure 41: Shock Pulse, X-axis Positive



Figure 42: Shock Pulse, X-axis Negative

7 Maintenance Instructions

The TIMTER™ transmitter requires no regular maintenance, and there are no user-serviceable parts inside.

8 Product Warranty

The TIMTER™ transmitter carries a standard parts and labor warranty of one (1) year from the date of delivery.

8.1 Quasonix Limited Warranty Statement

This Limited Warranty Statement (this “Limited Warranty”) applies to all hardware and software products and internal components of such products (the “Products”) sold by Quasonix, or its representatives, authorized resellers, or country distributors (collectively referred to herein as “Quasonix”). EXCEPT AS EXPRESSLY SET FORTH IN THIS LIMITED WARRANTY, QUASONIX MAKES NO OTHER WARRANTIES, EXPRESSED OR IMPLIED, INCLUDING ANY IMPLIED WARRANTIES OF MERCHANTABILITY OR FITNESS FOR A PARTICULAR PURPOSE WITH RESPECT TO ANY PRODUCTS SOLD BY IT. Quasonix expressly disclaims all warranties and conditions not stated in this limited warranty. There are no warranties which extend beyond the description on the face hereof. Capitalized terms not otherwise defined herein shall have the meaning set forth in those certain General Terms and Conditions of Sale for Standard Product, as amended from time to time.

Quasonix warrants to customer that for one (1) year from the date of shipment of the Products by Quasonix (the “Warranty Period”), such Products purchased from Quasonix or its authorized affiliate will materially conform to the specifications set forth in the applicable Quasonix Specifications, if any, and are free from defects in materials and workmanship under normal use during the Warranty Period. As used herein, “normal use” means the intended use of the Products for which it was designed by Quasonix.

This Limited Warranty extends only to the original purchaser of the Products and is not transferable to anyone who obtains ownership of the Products from the original purchaser.

Quasonix’s software, whether incorporated into the Products or sold separately, is warranted solely to the extent that problems or “bugs” are found in the software and affect the functional operation of the Products. At no time shall requests for changes in the software architecture or visual esthetics be considered a warranty item.

The Products are manufactured using new materials only. Replacement parts may be new or equivalent to new. Replacement parts are warranted to be free from defects in material or workmanship for thirty (30) days or for the remainder of the Warranty Period of the Products in which they are installed, whichever is longer.

During the Warranty Period, Quasonix will repair or replace the defective Products. All components or hardware products removed from the Products under this Limited Warranty become the property of Quasonix. All warranties are limited to the repair or replacement of the Products.

In no event shall Quasonix be liable for any special, consequential, incidental or indirect damages of any kind, including, without limitation, loss of profits, loss of data, “down-time,” loss of use or damage to other equipment, or personal injury or death, whether or not Quasonix has been advised of the possibility of such loss.

Notwithstanding anything to the contrary herein, Quasonix’s entire liability hereunder from any cause whatsoever and regardless of the form of action shall be limited to the amount actually received by Quasonix.

Quasonix shall not be liable for a breach of the warranty set forth in this Limited Warranty unless: (i) the customer gives written notice of the defect, reasonably described, to Quasonix’s Contracts Administrator within thirty (30) days of the time when customer discovers or ought to have discovered the defect and obtains a Return Materials Authorizations (“RMA”) number; (ii) Quasonix is given a reasonable opportunity after receiving the notice to examine such Products and customer (if requested to do so by Quasonix) returns such Products to Quasonix’s facility in Moorpark, CA, unless otherwise approved by Quasonix; and (iii) Quasonix reasonably verifies customer’s claim that the Products are defective.

Subject to the foregoing, with respect to any such Products during the Warranty Period, Quasonix shall, in its sole discretion, either: (i) repair or replace such Products (or the defective part) or (ii) credit or refund the price of such

Products at the pro rata contract rate provided that, if Quasonix so requests, customer shall, at Quasonix's expense, return such Products to Quasonix.

The customer is responsible for all costs associated with packaging and shipping of the defective Products to Quasonix's facility and clearly marking or affixing the given RMA number on the shipping label. Quasonix is not responsible for any loss or damage during shipment to Quasonix's facility. Following repair or replacement of covered Products, Quasonix will assume responsibility for the costs associated with the return of the material to the customer to an address provided by the customer. Notwithstanding the foregoing, items returned to Quasonix's facility and found to be operational or otherwise not covered by this Limited Warranty shall be returned to the customer at the customer's expense.

This Limited Warranty does not apply to expendable parts, such as cables, lamps, fuses, connectors, etc. This Limited Warranty does not extend to any Products which have been damaged or rendered defective (a) as a result of accident, misuse, abuse, or external causes; (b) by operation outside the usage parameters stated in the user documentation that shipped with the Products; (c) as a result of a failure to follow the instructions in the Operations & Maintenance Manual (d) by the use of parts not manufactured or sold by Quasonix; or (e) by modification or service by anyone other than (i) Quasonix, (ii) an Quasonix authorized service provider, or (iii) your own installation of end-user replaceable Quasonix or Quasonix approved parts if available for the Products in the servicing country.

THE TERMS OF THE WARRANTIES CONTAINED HEREIN DO NOT IN ANY WAY EXTEND TO ANY PRODUCT OR PART THEREOF OR SOFTWARE MATERIALS WHICH WERE NOT MANUFACTURED BY SELLER OR PREPARED BY SELLER OR ANY OF ITS AFFILIATES.

These terms and conditions constitute the complete and exclusive warranty agreement between the customer and Quasonix regarding the Products purchased. This Limited Warranty is applicable in all countries and may be enforced in any country where Quasonix or its authorized affiliates offer warranty service subject to the terms and conditions set forth in this Limited Warranty.

These terms and conditions supersede any prior agreements or representations (including representations made in Quasonix sales literature or advice given to the customer by Quasonix or an agent or employee of Quasonix) that may have been made in connection with the purchase of the Products. No change to the conditions of this Limited Warranty is valid unless it is made in writing and signed by an authorized representative of Quasonix.

8.1.1 Extended Warranties

Extended warranties or extra coverage are available upon request. Please contact Quasonix for details and pricing.

THE REMEDIES SET FORTH IN THIS LIMITED WARRANTY STATEMENT SHALL BE THE BUYER'S SOLE AND EXCLUSIVE REMEDY AND SELLER'S ENTIRE LIABILITY FOR ANY BREACH OF THE LIMITED WARRANTY SET FORTH HEREIN.

052217mbb002

9 Technical Support and RMA Requests

In the event of a product issue, customers should contact Quasonix via phone (1-513-942-1287) or e-mail (support@quasonix.com) to seek technical support. If the Quasonix representative determines that the product issue must be addressed at Quasonix, a returned materials authorization (RMA) number will be provided for return shipment.

Authorized return shipments must be addressed in the following manner:

**Quasonix, Inc.
ATTN: Repair, RMA #
6025 Schumacher Park Drive
West Chester, OH 45069**

To ensure that your shipment is processed most efficiently, please include the following information with your product return:

- Ship To – Company name, address, zip code, and internal mail-drop, if applicable
- Attention/Contact person – Name, Title, Department, Phone number, email address
- Purchase Order Number – If applicable
- RMA Number – provided by the Quasonix representative

Please note that Quasonix reserves the right to refuse shipments that arrive without RMA numbers.

10 Appendix A – Preset Option

The preset feature operates similar to the stored presets in a car radio. The presence of this option is designated by the characters “PS” and a number (2, 4, 8 or 16) appended to the standard model number. Transmitters with the preset option operate as follows:

1. The potential preset selection pins are pins 2, 6, 10, 11, 12 and 13 on the male MDM-15 connector, or pins 3, 7, 11, 12, 13 and 14 on the female MDM-15 connector. Of these pins, up to four may be used for presets depending on the device options. To see which pins are used for presets and which bits they represent, use the ZY command on the transmitter or refer to the documentation that came with your transmitter.
2. Left floating, (the pins are pulled up to 3.3 VDC internally), a pin represents a “0”, grounded is a “1”.
3. The 0000 state (all pins floating) provides normal operation.
4. The (up to) 15 other states (one or more pins grounded) select one of the presets.
5. Each preset stores a carrier frequency, modulation type, and various configuration values like randomizer, data inversion, differential encoding, etc. These settings can be viewed with the LC (list configurations) command from a terminal.
6. The preset pins are read only at power up. Changing the preset pins after power-on has no effect.
7. The presets are set (in your lab) from the 0000 state, using the “PS” or "SV" command. Storing a preset is done by configuring the device as you wish it to operate, then saving the setup to a particular preset. The save is performed by typing the following command:

SV x [name]

where x is the preset number (1-15 depending on the options) and name is an optional setup name stored with the setup. Alternatively, issue the “PS” command with a single-digit parameter (1 thru 15). So, “PS 5”, for example will store the current frequency and modulation setting in preset 5. “PS”, with no numeric value after it, reports the state of all presets. The LC command displays names for all setups or, if a setup number is entered, all the settings for that particular configuration.

8. Electrical connection note: The preset pins are connected directly to the FPGA in the unit, so it is important that the voltage on those pins never get outside the range of zero to 3.3 VDC. Voltages outside this range can cause permanent damage. Also, the internal pull-up is through a 25k Ohm resistor inside the FPGA, so it is important that the pins have a high impedance to ground (> 1 M Ohm) when the pins are floating. A true switch closure is ideal, although a transistor switch can be used as long as its “Off” impedance is sufficiently high.

11 Appendix B – Legacy Binary Protocol Notes

This information is intended for transmitter owners considering the use of Quasonix transmitter binary protocol. Check with Quasonix to see which version of binary protocol is supported by your transmitter.

11.1 Known Limitations of Binary Protocol \leq V1.005

These items are supported by the Quasonix legacy transmitter but NOT by the (old) version of binary protocol on the transmitter:

- Automatic Carrier Output – AC command is not supported (even with the AC option)
- Convolutional Encoding – CC command is not supported (even with the CE option)
- Clock Polarity – CP command does not support Auto, only 0 and 1; also if CP was set to A using Terminal, the only way to change the setting to 0 or 1 is also via Terminal
- Clock Free Bit Rate – BR command is not supported
- Clock Free – CF option is not supported
- Customer number – No way to return it using binary protocol
- Frequency Step – FS command is not implemented
- High Power – HP command is not supported (even with DP option)
- Low Density Parity Check (LDPC) – LD option is not supported
- Low Power – LP command is not supported (even with the DP option)
- Model number – Not implemented, no way to return it using binary protocol
- Modulation Scaling – MS command is not supported (even with the MS option)
- NRZ-M Conversion – MC command is not supported (even with the CE option)
- Overtemperature Control – OC command is not supported
- Recall Setup – RC command is not supported
- RF On/Off Pin Polarity – RZ command is not supported
- Version – VE command is not supported; On “Bad Tag” message, assume \leq V1.005

- Missing Option notification – Not supported

11.2 Items Not Supported By the Legacy Transmitter

- Extended LDPC – LD6 option is not supported
- CCSDS Randomizer – RA 2 command when LD is enabled is not supported
- Detected Bit Rate – Not supported
- Over the Air Bit Rate – Not supported
- PA Voltage or Current – No provision for returning this data

12 Appendix C – Understanding Clock/Data, AC, and BR

It is important to understand clock and data priorities when using a Quasonix transmitter. Table 21 describes the possible settings for Internal Clock, Clock Free, Clock Free Bit Rate, External Clock, External Data, and Automatic Carrier Output, and the resulting RF output.

Clock and data logic (where they come from and how they are selected) is shown in Figure 43.

When set to internal clock source (CS 1), the data source must also be set to internal via the DS command (DS 1) in order to have synchronous, usable data.

For details about specific commands, refer to AC, BBCK, BR, CF, or IC.

Table 21: Transmitter Priority of CS, CF, BR, and AC When RF is On

CS	CF	BR auto/manual	Ext Clk In	Ext Dat In	AC	RF Out
1	x	x	x	x	x	RF out is based on IC and ID
0	0	Auto	x	present	x	RF out is based on auto CF rate derived from ext data input
0	0	Auto	x	not present	0	RF Off
0	0	Auto	x	not present	1	RF stick at Carrier frequency
0	0	Manual	x	x	x	RF out based on BR setting (may be trash if no data is present or rate is wrong on ext dat input)
0	1	x	present	x	x	RF out based on ext clock and data (may be trash if no data is present on ext dat input)
0	1	x	not present	x	0	RF Off
0	1	x	not present	x	1	RF stick at Carrier frequency

*Note that 'x' means 'don't care'

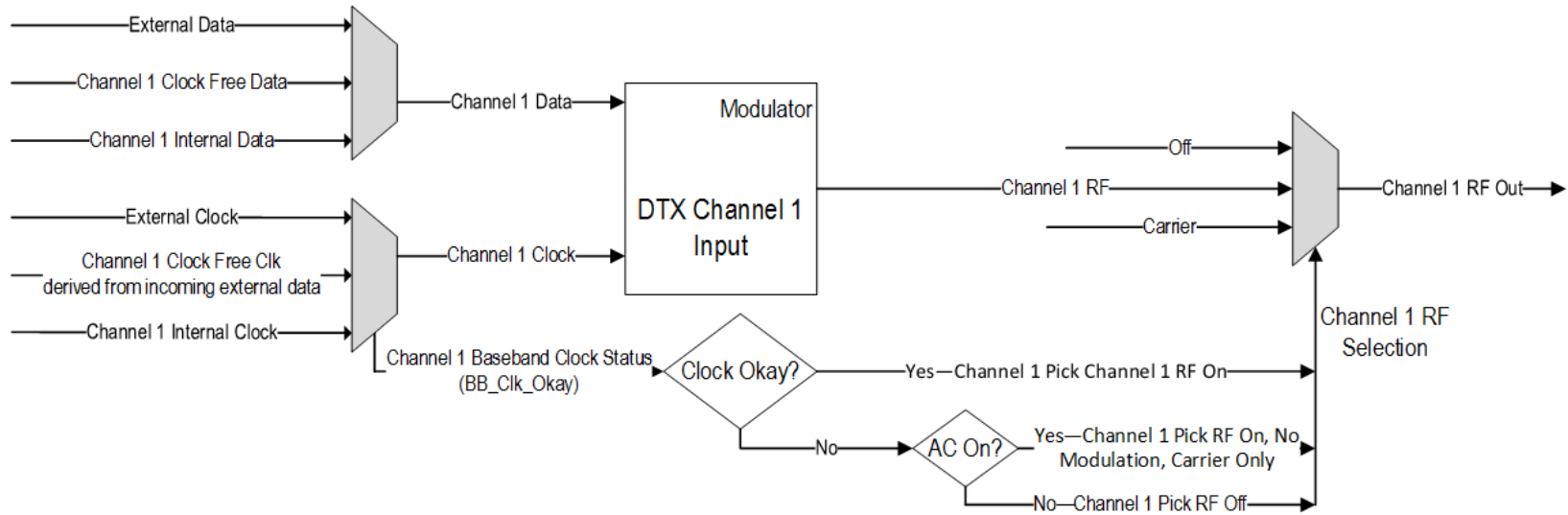

Figure 43: Transmitter Clock and Data Logic

13 Appendix D – Acronym List

Acronym	Description
A	Amperes (amps)
AC	Automatic Carrier Wave option
AM	Amplitude Modulation
AQPSK	Variant of Quadrature Phase Shift Keying
ARTM	Advanced Range Telemetry
AUQPSK	Variant of Quadrature Phase Shift Keying
BER	Bit Error Rate
BNC	Bayonet Neill-Concelman Connector (RF Connector)
BPSK	Binary Phase Shift Keying
CF	Clock Free option
CG	Clock Generator option
CPM	Continuous Phase Modulation
DB	Data Bias Level option
DB-9	D-subminiature 9 pin Serial Connector
DD	Debounce Delay
DE	Differential Encoding
DDS	Direct Digital Synthesizer
DP	Data Polarity option
DP	Dual Power
DS	Data Source option
FPGA	Field Programmable Gate Array
FS	Frequency Step
HR	High Bit Rate
ID	Internal Data
kbps	Kilobits per second
kHz	Kilohertz
LC	List Configurations option
LR	Low Bit Rate

Acronym	Description
LS	Lower S-band
MA	Modulations Allowed option
Mbps	Megabits per second
MHCPM	multi-h Continuous Phase Modulation
MHz	Megahertz
MO	Modulation
mwatt	Megawatt
N	(connector type) Threaded RF connector
OQPSK	Offset Quadrature Phase Shift Keying
PCMFm	Pulse Code Modulation/Frequency Modulation
PF	Parallel Port Frequency
PL	Power Level
PM	Parallel Port Mode
PM	Phase Modulation
PSK	Phase Shift Keying
PW	Parameter Write option
QPSK	Quadrature Phase Shift Keying
QT	Query Temperature option
RC	Recall Configuration option
RF	Radio Frequency
RG	Reverse Gender option
RJ-45	Ethernet Connection Jack
RN	Randomizer option
RS-232	Recommended Standard 232 (Serial Communications)
SC	Startup Configuration option
SN	Serial Number
SOQPSK	Shaped Offset Quadrature Phase Shift Keying
SOQPSK-TG	Shaped Offset Quadrature Phase Shift Keying –Telemetry Group
SV or PS	Preset Save option

Acronym	Description
TIMTER	Tier I Missile Test Transmitter
TRL	Tracking Loop
TTL	Transistor Transistor Logic
UDP	User Datagram Protocol
UQPSK	Unbalanced Quadrature Phase Shift Keying
US	Upper S-band
USB	Universal Serial Bus
UUT	Unit Under Test
VAC	Voltage Alternating Current
VDC	Voltage Direct Current
VP	Variable Power option
VR	Variable Reference Level
VSWR	Voltage Standing Wave Ratio
W	Watt
WAN	Wide Area Network
WV	Wide Input Voltage Range option